

Exposed part for con.thermo.shower valve, 3-outlet CUBIC_CU018200



MODEL **CU018200**

Exposed part for con.thermo.shower valve, 3-outlet, with 3 outlet devistop, without concealed part, for item ZA018201

AVAILABLE FINISHINGS

-  **21** 21 Chrome
-  **2B** 2B Polished Nickel
-  **2F** 2F Brushed Nickel
-  **40** 40 Matt Black

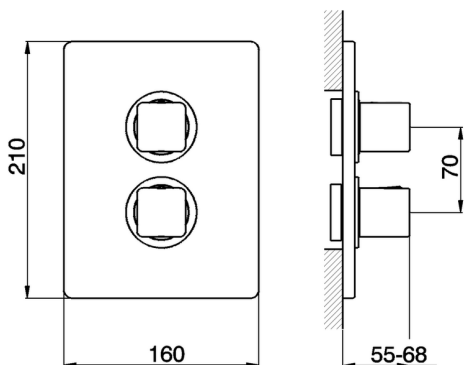

CHARACTERISTICS

Installation **Concealed**
 Required concealed parts **ZA018201**



Thermostatic

The Cisal thermostatic is your personal water manager, helping you to handle, control and save water and energy.



Exposed part for con.thermo.shower valve, 3-outlet CUBIC_CU018200

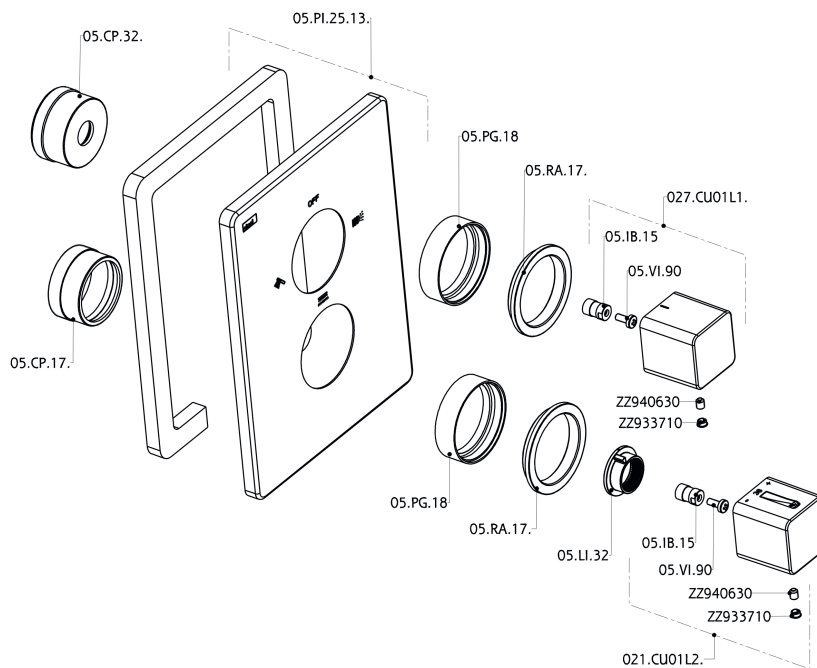

CU018200

<https://en.cisal.it/exposed-part-for-con-thermo-shower-valve-3-outlet-cubic-cu018200>

Concealed thermostatic shower valve, 3-outlets CONCEALED_ZA018201

MODEL **ZA018201**

Concealed thermostatic shower valve, 3-outlets, with 1/2" 3 outlet deviastop cartridge, without trim kit



AVAILABLE FINISHINGS

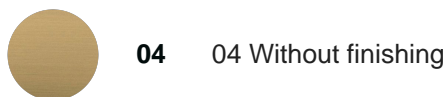

CHARACTERISTICS

Concealed **1**
 Cartridge Spare Parts **24.04A.PP**
8x20 Plus P Thermostatic Valve

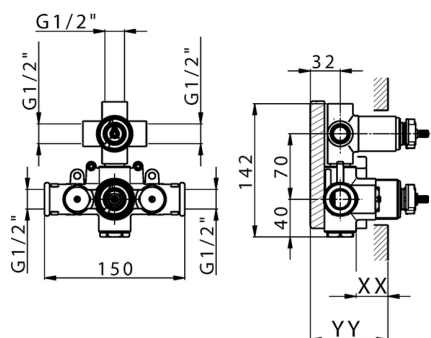

Piastra/Plate/Plaque/Platte/Placa
 2-3mm: XX 25-40 YY 76-91
 10 mm: XX 16-31 YY 65-80



DeviaStop

The Cisal Devia Stop technology allows to adjust the water flow and to direct it to the selected output point (overhead soaker, hand shower, etc).



Thermostatic

The Cisal thermostatic is your personal water manager, helping you to handle, control and save water and energy.



2026-05-19