

S.L. washbasin mixer- tall version - EnergySave ALMA_A3003545

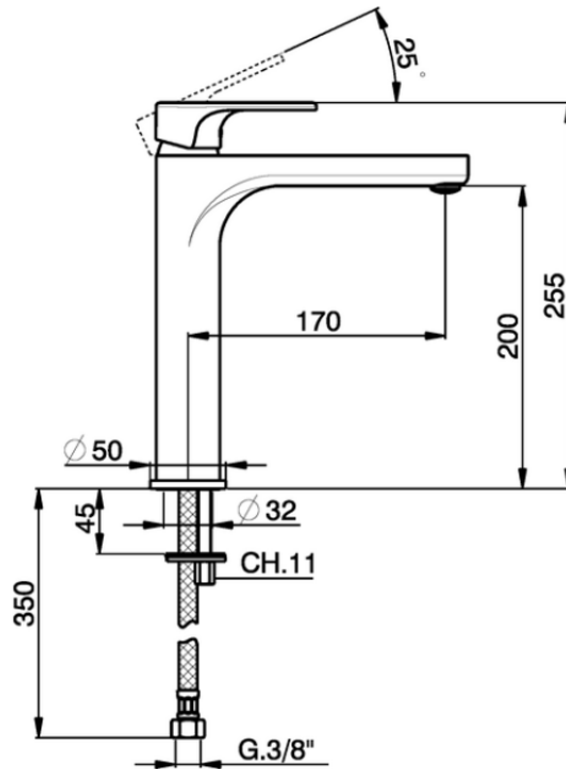

A3003545

<https://en.cisal.it/s-l-washbasin-mixer-tall-version-energysave-alma-a3003545>

2026-04-09