



## Thermostatic shower column, 2-functions BARCELONA\_BA004080

MODEL **BA004080**

Thermostatic shower column, 2-functions, 2 outlet diverter, adjustable riser column, with not sliding handshower bracket, Brass minimalistic one spray handshower, 200 mm Round Head Shower, 150 cm PVC Flexible Hose



### AVAILABLE FINISHINGS

-  **21** 21 Chrome
-  **2A** 2A Satin Brushed Nickel
-  **40** 40 Matt Black

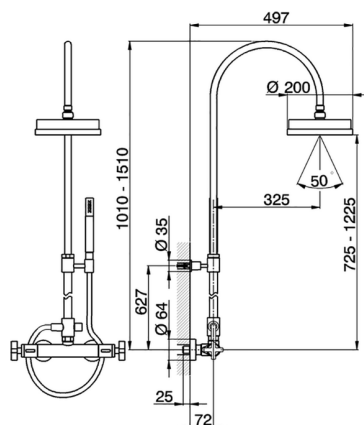

### CHARACTERISTICS

Cartridge Spare Parts **22.03A.AR - ZZ97080004**

**Argo 1 (short filter) Thermostatic Valve**



#### EcoStop

EcoStop feature limits water flow to approximately 50% of maximum output with one point of resistance on setting. Push slightly past the middle stop only when full water output is required. This will save water up to 50%.



#### Thermostatic

The Cisal thermostatic is your personal water manager, helping you to handle, control and save water and energy.



## Thermostatic shower column, 2-functions BARCELONA\_BA004080

# cisal

**BA 00408 0**

da Febbraio 2009 - from February 2009  
ab Februar 2009 - de Février 2009

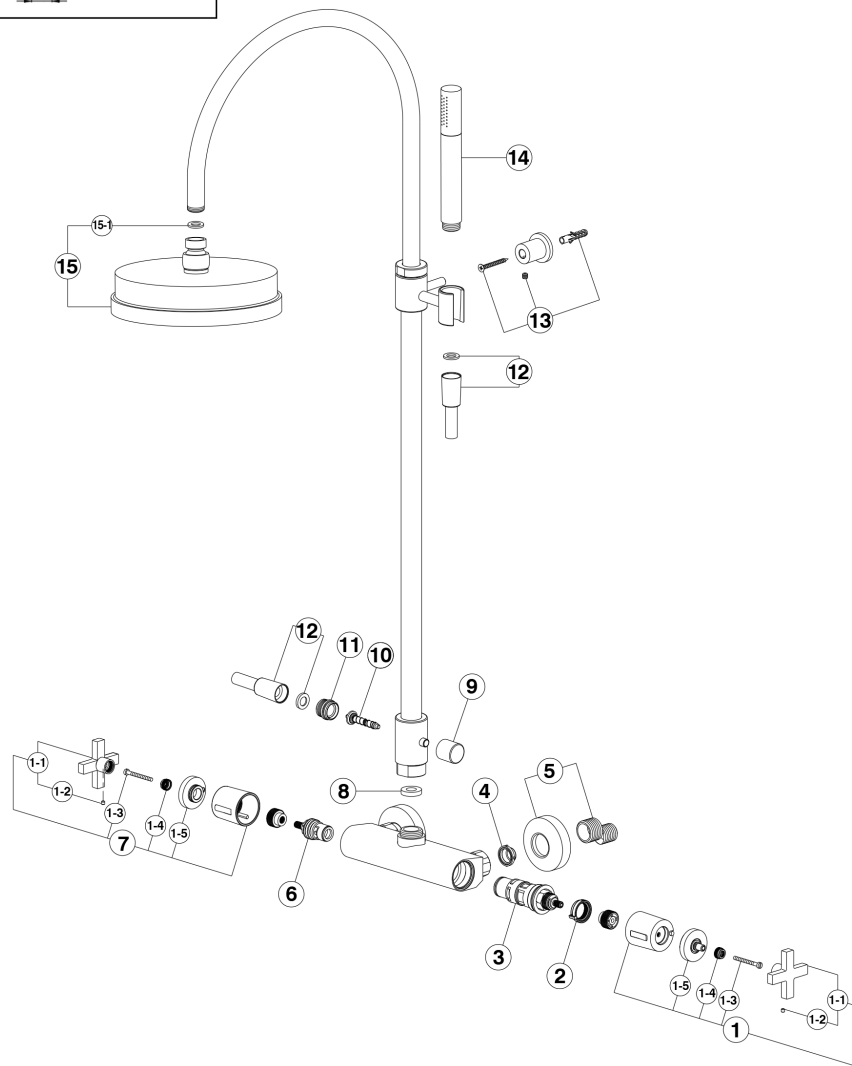
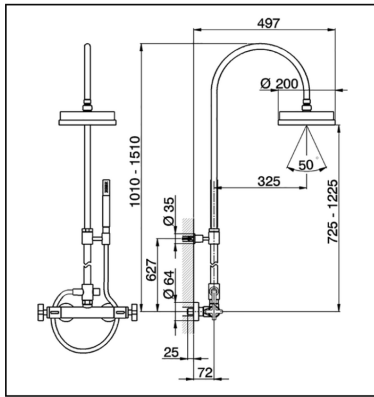

BA004080

<https://en.cisal.it/thermostatic-shower-column-2-functions-barcelona-ba004080>

## Thermostatic shower column, 2-functions BARCELONA\_BA004080

# cisal

**BA 00408 0**

 da Febbraio 2009 - from February 2009  
 ab Februar 2009 - de Février 2009

NR.	DESCRIZIONE DESCRIPTION BESCHREIBUNG DESCRIPTION	N.CODICE CODE NO. WERSKNR. NR.CODE	NR.	DESCRIZIONE DESCRIPTION BESCHREIBUNG DESCRIPTION	N.CODICE CODE NO. WERSKNR. NR.CODE	NR.	DESCRIZIONE DESCRIPTION BESCHREIBUNG DESCRIPTION	N.CODICE CODE NO. WERSKNR. NR.CODE
1	Maniglia "BA" regolazione temperatura Croisillon "BA" gradué Handle - temperature set-up "BA" Griff "BA" Temperaturbergrenzer	ZZ935620	5	Eccentrico con rosone Excentrique + rosace Excentric connection with escutcheon S - Anschluss m.Rosette	ZZ946000	9	Pomolo per deviazione Pommeau pour inverseur Knob for diverter Zugknopf Umsteller	ZZ933290
1-1	Maniglia "BQ" per monofori Croisillon "BQ" pour mélangeur monotrou Handle "BQ" for single hole mixer Griff "BQ" f/Einloch-Batterien	ZZ945990	6	Vitone ceramico 1/2 destro 180° term. Tête céramique 1/2 droite 180° therm. Ceramic headvalve 1/2 right 180° therm. Keramikoberteil 1/2 rechts 180°Therm.	ZZ945890	10	Asta deviazione completa Tige inverseur complète Complete diverting rod Umstellung	ZZ933140
1-2	Grano punta piana inox M.4x4 Vis speciale inox M.4x4 Screw stainless steel M.4x4 Madenschraube M.4x4	ZZ933280	7	Maniglia "BA" regolazione portata Croisillon "BA" débit Handle - flow rate control "BA" Griff "BA" f/Absperrung	ZZ935650	11	Attacco flessibile Raccord flex Flexible connection Flex Anschluss	ZZ931410
1-3	Vite M.4x40 t.c. tc. Vis M.4x40 Screw M.4x40 Schraube M.4x40	ZZ926790	7-1	Maniglia "BQ" per monofori Croisillon "BQ" pour mélangeur monotr. Handle "BQ" for single hole mixer Griff "BQ" f/Einloch-Batterien	ZZ945990	12	Flex PVC 150 cm Ø14 1/2" x 1/2" conico Flexible PVC 150 cm Ø14 1/2" x 1/2" Flex PVC 150 cm Ø14 1/2" x 1/2" Braueschl. PVC 150 cm Ø14 1/2" x 1/2"	ZZ9A9550
1-4	Riduzione brocciata completa Reduction avec brochage complete Complete broached reduction piece Verkuerzung Raemwerkzeug komplett	ZZ933300	7-2	Grano punta piana inox M.4x4 Vis speciale inox M.4x4 Screw stainless steel M.4x4 Madenschraube M.4x4	ZZ933280	13	Set installazione asta doccia Set installation colonne de douche Installation set for sliding bar Installationsset für Wandstange	ZZ949870
1-5	Placchetta maniglia BA per thermost. Plaqueette croisillon BA pour thermost. Cap BA handle for thermostatic mixer Abdeckkappe Griff BA fuer Thermost.	ZZ935640	7-3	Vite M.4x40 t.c. tc. Vis M.4x40 Screw M.4x40 Schraube M.4x40	ZZ926790	14	Doccia minimale Douchette minimal Minimal handshower Handbrause minimal Soffione doccia	DS014090
2	Ghiera limitatrice di temperatura "H2" Ecrou - limiteur temperat. "H2" Nut - temperature device "H2" Temperaturbgr-ring "H2"	ZZ945840	7-4	Riduzione brocciata completa Reduction avec brochage complete Complete broached reduction piece Verkuerzung Raemwerkzeug kompl.	ZZ933300	15	Pomme de douche Headshower Kopfbrause	DS016100
3	Cartuccia miscelatore termostatico "H2" Cartouche "H2" mural Thermostatic valve-wall mount mixer "H2" Thermoelement - UP - "H2"	ZZ970800	7-5	Placchetta maniglia BA per thermost. Plaqueette croisillon BA pour thermost. Cap BA handle for thermostatic mixer Abdeckkappe Griff BA fuer Thermost.	ZZ935640	15-1	Guarnizione fibra 18,5x11x2 Joint en fibre 18,5x11x2 Gasket rubber 18,5x11x2 Fiberdichtung 18,5x11x2	ZZ927140
4	Guarnizione con filtro Joint avec filtre Gasket with filter Dichtung mit filter	ZZ945870	8	Guarnizione NBR 90 SH. 24x16x2 Joint NBR 90 SH. 24x16x2 Gasket NBR 90 SH. 24x16x2 Dichtung NBR 90 SH. 24x16x2	ZZ926890			

BA004080

<https://en.cisal.it/thermostatic-shower-column-2-functions-barcelona-ba004080>

2026-06-13