

Exposed part for single-lever bath shower mixer LESS MINIMAL_LN014200C

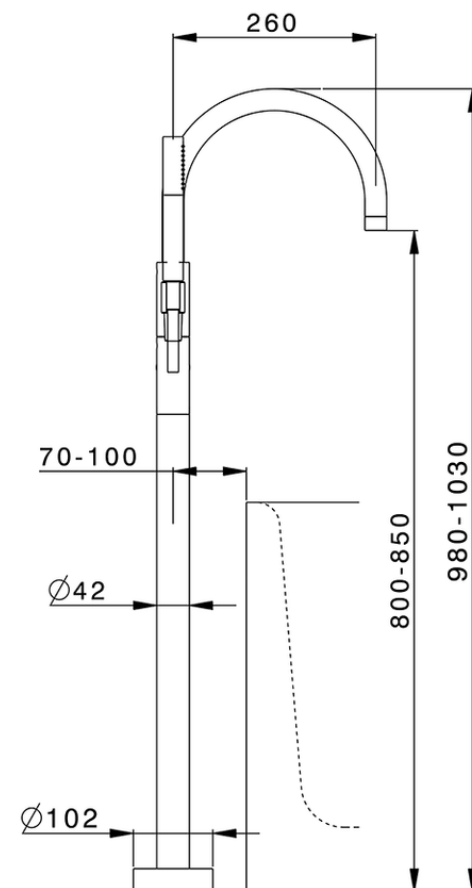

LN014200C

<https://en.cisal.it/exposed-part-for-single-lever-bath-shower-mixer-less-minimal-ln014200c>



ZA004510

<https://en.cisal.it/concealed-part-single-lever-free-standing-concealed-za004510>

2026-04-27