

## Exposed part for Thermostatic One Box Valve ARCANA CERAMIC\_AC0BT030

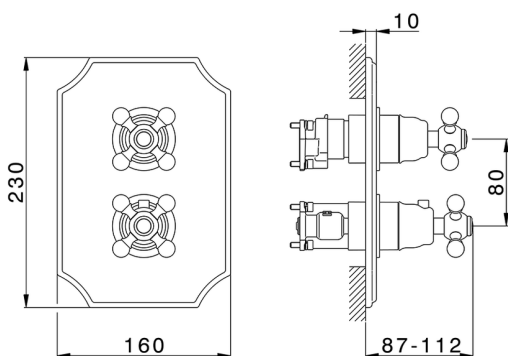
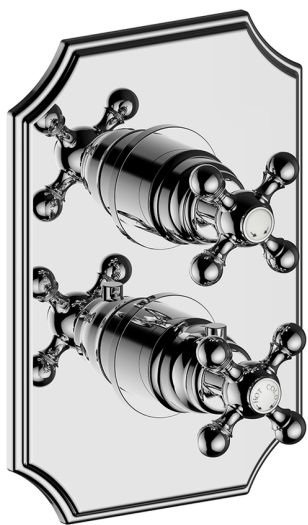

MODEL **AC0BT030**

Exposed part for Thermostatic One Box Valve, with 1-2-3 outlet deviator, Minimum depth of installation: 67 mm, without concealed part, for items ZA00B030-ZA00B031

### AVAILABLE FINISHINGS

-  **21** 21 Chrome
-  **24** 24 Gold
-  **26** 26 Old Copper
-  **27** 27 Old Bronze
-  **2A** 2A Satin Brushed Nickel
-  **74** 74 Chrome/Gold

### CHARACTERISTICS

Cartridge Spare Parts **24.04A.PP**

**8x20 Plus P Thermostatic Valve**

Installation **Concealed**

Required concealed parts **ZA00B031**

**ZA00B030**



### Thermostatic

The Cisal thermostatic is your personal water manager, helping you to handle, control and save water and energy.



## Exposed part for Thermostatic One Box Valve ARCANA CERAMIC\_AC0BT030

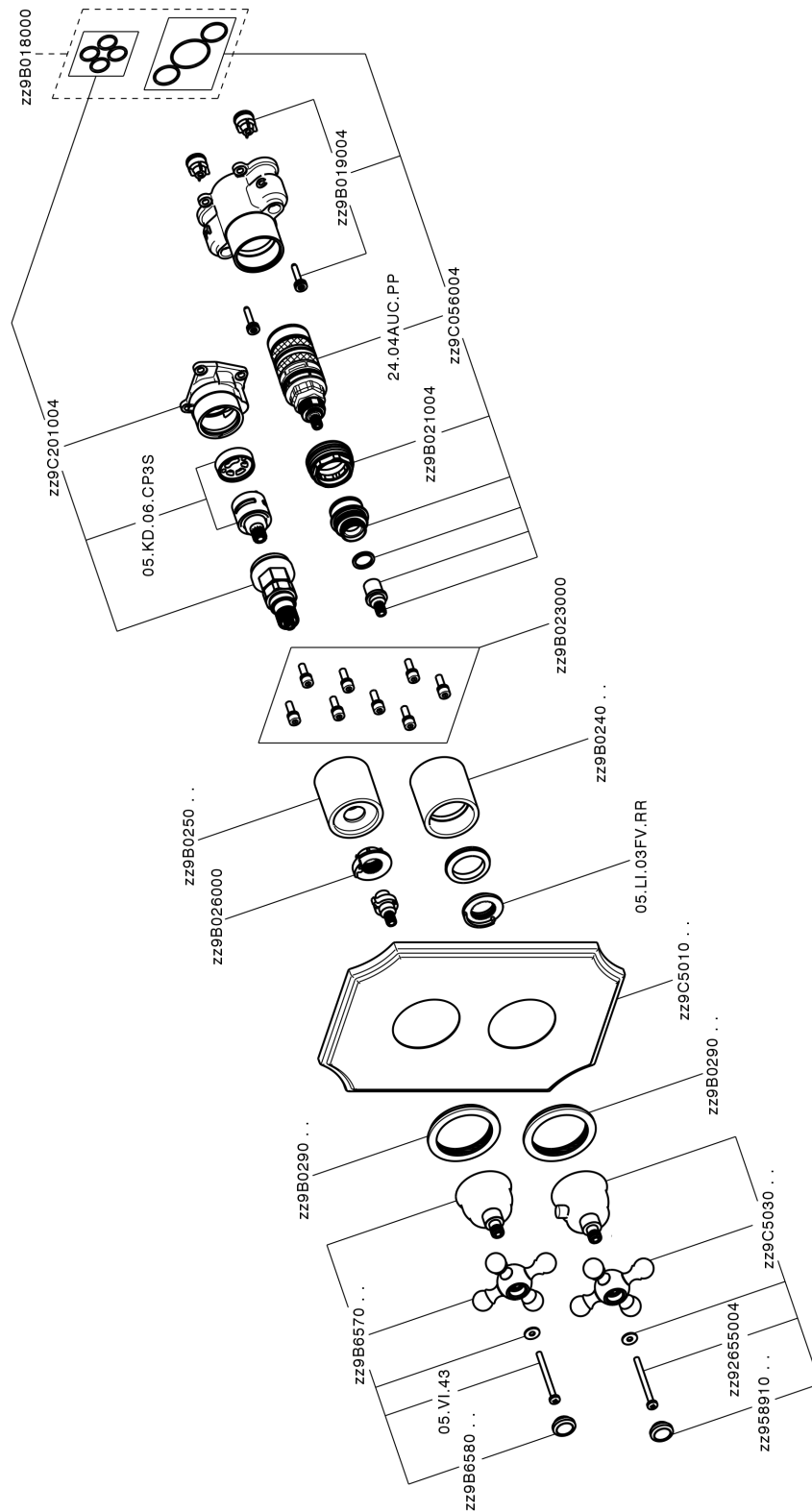

AC0BT030

<https://en.cisal.it/exposed-part-for-thermostatic-one-box-valve-arcana-ceramic-ac0bt030>

## One Box Universal Concealed Part ONE BOX\_ZA00B031

MODEL **ZA00B031**

One Box Universal Concealed Part, for 1, 2 or 3 outlet thermostatic or single lever, without trim kit, with noise reducers, with sealing gasket

AVAILABLE FINISHINGS

 **04** 04 Without finishing

CHARACTERISTICS

Concealed **1**



### Thermostatic

The Cisal thermostatic is your personal water manager, helping you to handle, control and save water and energy.



## One Box Universal Concealed Part ONE BOX\_ZA00B030

MODEL **ZA00B030**

One Box Universal Concealed Part, for 1, 2 or 3 outlet thermostatic or single lever, without trim kit, without noise reducers, with sealing gasket

AVAILABLE FINISHINGS

 **04** 04 Without finishing

CHARACTERISTICS

Concealed **1**



### Thermostatic

The Cisal thermostatic is your personal water manager, helping you to handle, control and save water and energy.



2026-06-10