

Exposed part for con.thermo.shower valve, 2-outlet GRACE_GS019641

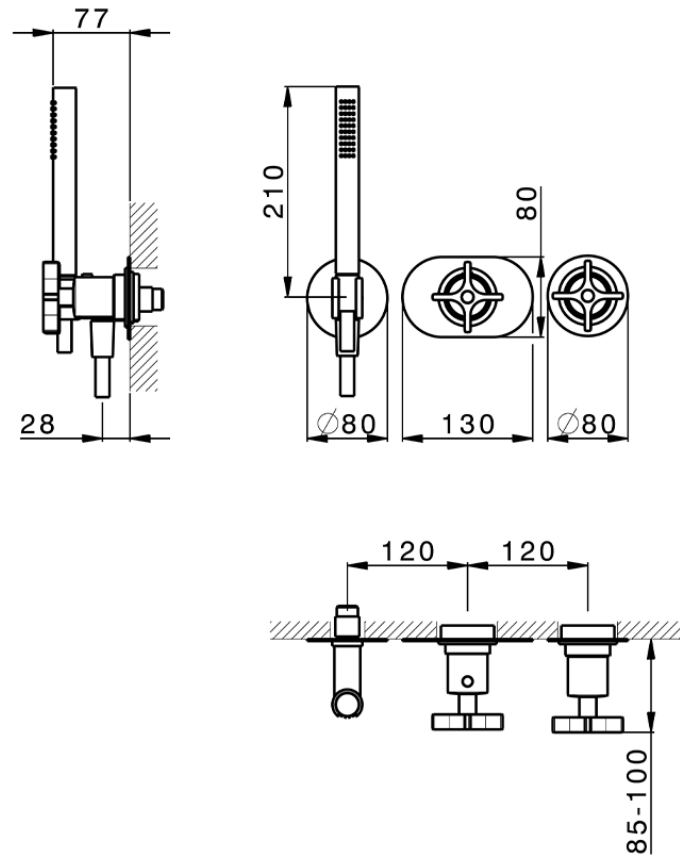

GS019641

<https://en.cisal.it/exposed-part-for-con-thermo-shower-valve-2-outlet-grace-gs019641>

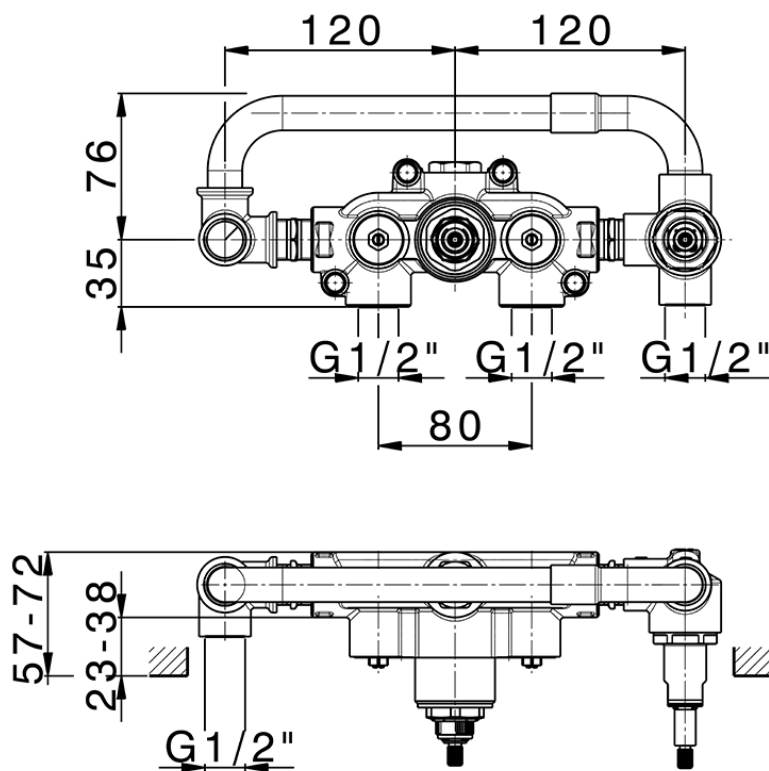

ZA019340

<https://en.cisal.it/concealed-thermostatic-shower-mixer-2-outlets-concealed-za019340>

2026-04-28