

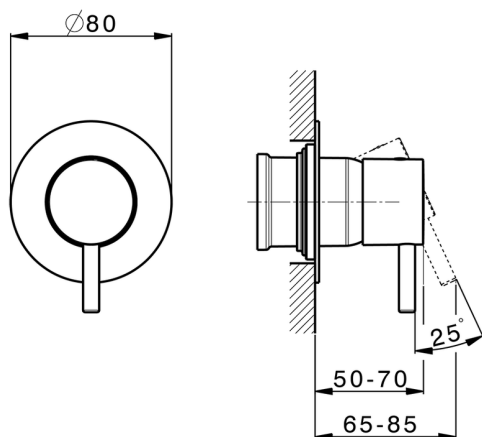



Exposed part for concealed S.L. shower valve NUOVA LESS_LN003000C

MODEL **LN003000C**

Exposed part for concealed S.L. shower valve, without concealed part, for item ZA005300-ZA0G1700



AVAILABLE FINISHINGS

-  **21** 21 Chrome
-  **2F** 2F Brushed Nickel
-  **40** 40 Matt Black
-  **4Q** 4Q Matt White
-  **2W** 2W Brushed Gold
-  **26** 26 Old Copper
-  **3W** 3W Brushed Black Titanium
-  **43** 43 Salvia
-  **44** 44 Graphite
-  **45** 45 Argilla
-  **46** 46 Metal Bronze
-  **47** 47 Cemento

CHARACTERISTICS

Installation **Concealed**

Required concealed parts **ZA0G1700**

ZA005301

ZA005300



Concealed single lever shower mixer CONCEALED_ZA005301

MODEL **ZA005301**

Concealed single lever shower mixer, 1/2" concealed shower, without trim kit, with noise reducers



AVAILABLE FINISHINGS



CHARACTERISTICS

Concealed **1**
 Cartridge Spare Parts **ZZ94035000**
35 mm Cartridge

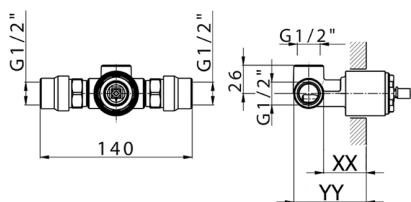

Piastra/Plate/Plaque/Platte/Placa
 2-3mm: XX 27-47 YY 54-74
 10mm: XX 16-40 YY 43-68



Concealed single lever shower mixer CONCEALED_ZA005300



MODEL **ZA005300**

Concealed single lever shower mixer, 1/2" concealed shower, without trim kit

AVAILABLE FINISHINGS

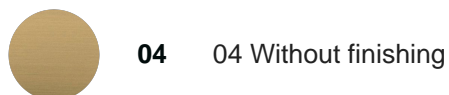

04 04 Without finishing

CHARACTERISTICS

Concealed **1**
 Cartridge Spare Parts **ZZ94035000**
35 mm Cartridge

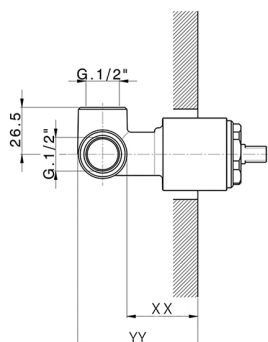

Piastra/Plate/Plaque/Platte/Placa
 2-3mm: XX 27-47 YY 54-74
 10mm: XX 16-40 YY 43-68



2026-05-19