

Extension +15 mm COMPONENTS_ZA000440

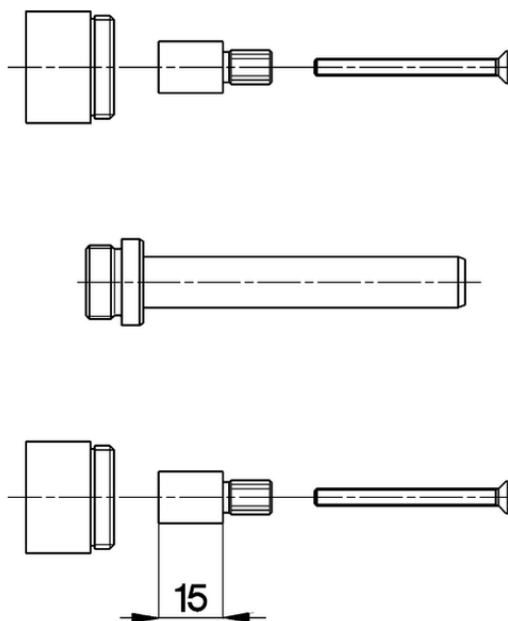

ZA000440

<https://en.cisal.it/extension-15-mm-components-za000440>

2026-04-29