







## Toilet paper holder reserve BATHROOM ACCESSORIES\_QU090410

MODEL **QU090410**

Toilet paper holder reserve

AVAILABLE FINISHINGS

-  **21** 21 Chrome
-  **2B** 2B Polished Nickel
-  **2F** 2F Brushed Nickel
-  **2Q** 2Q Black Titanium
-  **40** 40 Matt Black
-  **4Q** 4Q Matt White

CHARACTERISTICS

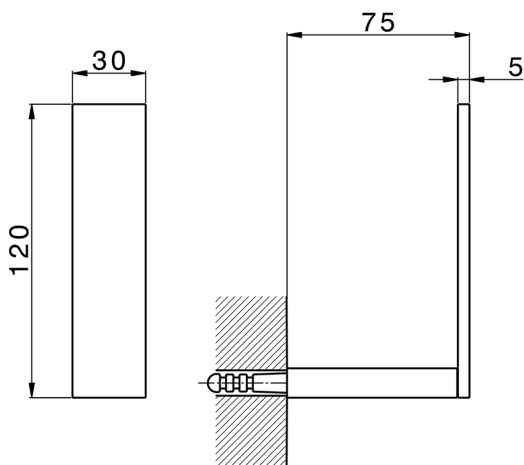
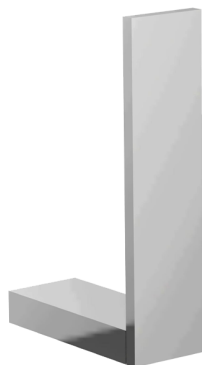

2024-12-27