

Concealed urinal electronic valve TRONIC_TN002710

MODEL **TN002710**

Concealed urinal electronic valve, battery supply

AVAILABLE FINISHINGS



CHARACTERISTICS

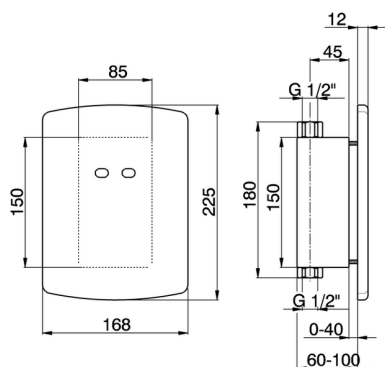

Concealed urinal electronic valve TRONIC_TN002710

cisal

TN 00271 0 (TN 00271 1)

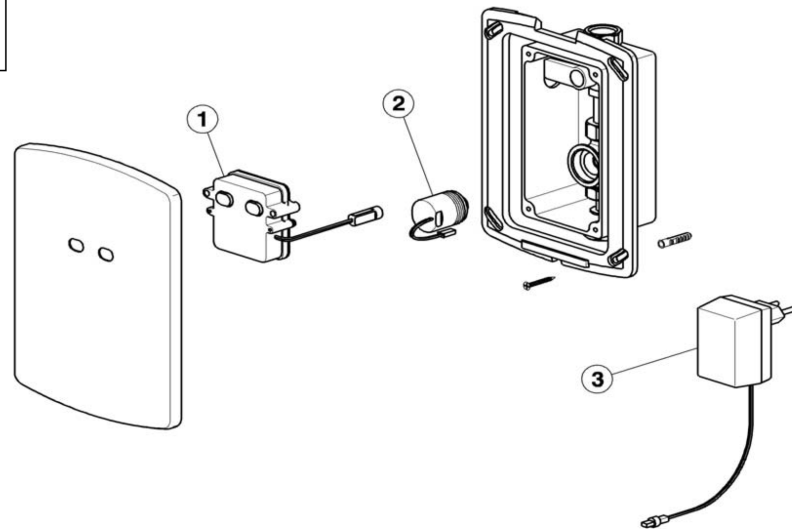
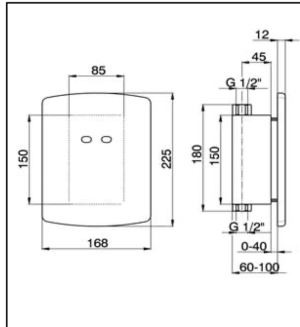

NR	DESCRIZIONE DESCRIPTION DESCRIPTION BESCHREIBUNG DESCRIPCIÓN	N.CODICE NR.CODE CODE NO. WERSKNR. N.CÓDIGO	NR	DESCRIZIONE DESCRIPTION DESCRIPTION BESCHREIBUNG DESCRIPCIÓN	N.CODICE NR.CODE CODE NO. WERSKNR. N.CÓDIGO	NR	DESCRIZIONE DESCRIPTION DESCRIPTION BESCHREIBUNG DESCRIPCIÓN	N.CODICE NR.CODE CODE NO. WERSKNR. N.CÓDIGO
	. Parte elettronica orinatoio inc.a batteria . Electr.pour urinoir encastr.- alim.par pile							
1	. Electronic set for concealed battery urinal set . Parte electrónica urinario por empotrar c/bate . Elektronik f/UP-Urinalarmatur - Batteriebetrieb	ZZ950450						
1	. Parte elettronica orinatoio inc.a rete . Electr.pour urinoir encastr.-alim.pour brancher	ZZ950460						
	. Electronic set for concealed net urinal set . Parte electrónica urinario por empotrar de rec . Elektronik f/UP-Urinalarmatur - Netzbetrieb							
2	. Electrovalvola per lavabo . Electronvanne pour lavabo	ZZ950360						
	. Electronic valve for basin . Electroválvula para lavabo . Elektroventil für Waschtschbatterie							
3	. Trasformatore per orinatoio incasso . Transformateur pour urinoir encastrer	ZZ950470						
	. Transformer for concealed net urinal set . Transformador para urinario por empotrar . Steckernetzteil f/UP-Urinalarmatur							

TN002710

<https://en.cisal.it/concealed-urinal-electronic-valve-tronic-tn002710>

2026-06-14