

## Concealed rapid flow valve ARCANA COMPONENTS\_AR002710

MODEL **AR002710**

Concealed rapid flow valve

AVAILABLE FINISHINGS

-  **21** 21 Chrome
-  **24** 24 Gold
-  **26** 26 Old Copper
-  **27** 27 Old Bronze
-  **2A** 2A Satin Brushed Nickel

CHARACTERISTICS

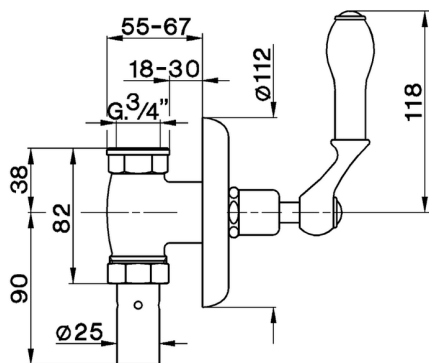

## Concealed rapid flow valve ARCANA COMPONENTS\_AR002710

# cisal

## AR 00271

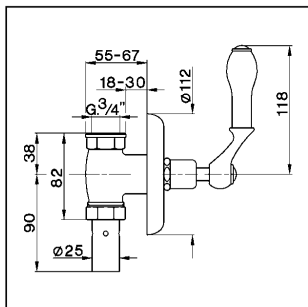

- Rubinetto passo rapido incasso per W.C.
- Concealed rapid flow valve
- WC-Spülventil
- Robinet pour W.C. à encastrer

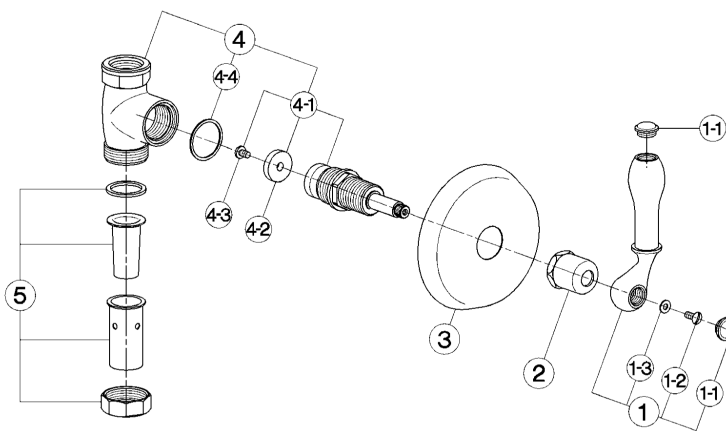

bar	PORTATA * FLOW RATE DURCHFLOSS DEBIT l/min.
0.1	14
0.2	20
0.3	25.5
0.4	29
0.5	32.5
1	48

\* senza resistenza silenziosa (uscita libera)  
without hydraulic resistance  
ohne Widerstand  
sans résistance hydraulique

NR.	DESCRIZIONE DESCRIPTION BESCHREIBUNG DESCRIPTION	N. CODICE CODE NO. WERKSNR. NR. CODE	NR.	DESCRIZIONE DESCRIPTION BESCHREIBUNG DESCRIPTION	N. CODICE CODE NO. WERKSNR. NR. CODE	NR.	DESCRIZIONE DESCRIPTION BESCHREIBUNG DESCRIPTION	N. CODICE CODE NO. WERKSNR. NR. CODE
1	Maniglia per passo rapido "AR" Handle rapid flow "AR" Hebel-Schnelldurchlauf "AR" Croisillon robinet W.C. "AR"	ZZ 90306 0	4	Rubinetto passo rapido incasso 3/4" Concealed rapid flow 3/4" WC - Ventil 3/4" Robinet W.C. 3/4"	ZZ 92762 0	5	Codulo completo per passo rapido 3/4" Connection for rapid flow 3/4" Verbindungsstück pass. zu WC-Ventil 3/4" Ecorou pour robinet WC 3/4"	ZZ 92763 0
1-1	Placchetta a vite maniglia "AR" Cap for handle "AR" Abdeckkappe "AR" Griff Plaque cache - vis crois. "AR"	ZZ 92617 0	4	Rubinetto passo rapido incasso 1" Concealed rapid flow 1" WC - Ventil 1" Robinet W.C. 1"	ZZ 92765 0	5	Codulo completo per passo rapido 1" incasso Connection for rapid flow 1" Verbindungsstück pass. zu WC-Ventil 1" Ecorou pour robinet WC 1"	ZZ 92764 0
1-2	Vite M 4,5x10 tb. te. zigrinata Screw M 4,5x10 Schraube M 4,5x10 Vis M 4,5x10	ZZ 92609 0	4-1	Vitone per passo rapido incasso Rapid flow headvalve Oberteil UP-W.C. Ventil Tête robinet W.C.	ZZ 92782 0			
1-3	Rondella ottone 10x4,5x0,8 Ring in brass 10x4,5x0,8 Unterlegscheibe 10x4,5x0,8 Joint laiton 10x4,5x0,8	ZZ 92663 0	4-2	Guarnizione NBR 90 SH. 24x6,5x5 Gasket NBR 90 SH. 24x6,5x5 Dichtung NBR 90 SH. 24x6,5x5 Joint NBR 90 SH. 24x6,5x5	ZZ 92709 0			
2	Cappuccio coprivite per passo rapido Escutcheon rapid flow valve Abdeckkappe 1"WC-Ventil Rosace couvre-tête WC	ZZ 92631 0	4-3	Vite W 3/16"x7,5 tb. Screw W 3/16"x7,5 Schraube W3/16"x7,5 Vis W 3/16"x7,5	ZZ 92621 0			
3	Rosone per passo rapido Escutcheon rapid flow valve Rosette 1"WC-Ventil Rosace - robinet WC "AR"	ZZ 92630 0	4-4	Guarnizione alluminio 32x28,2x1 Gasket aluminium 32x28,2x1 Dichtung 32x28,2x1 Joint aluminium 32x28,2x1	ZZ 92646 0			

AR.19

AR002710

<https://en.cisal.it/concealed-rapid-flow-valve-arcana-components-ar002710>

2026-06-05