

Spout COMPONENTS_ZA001250

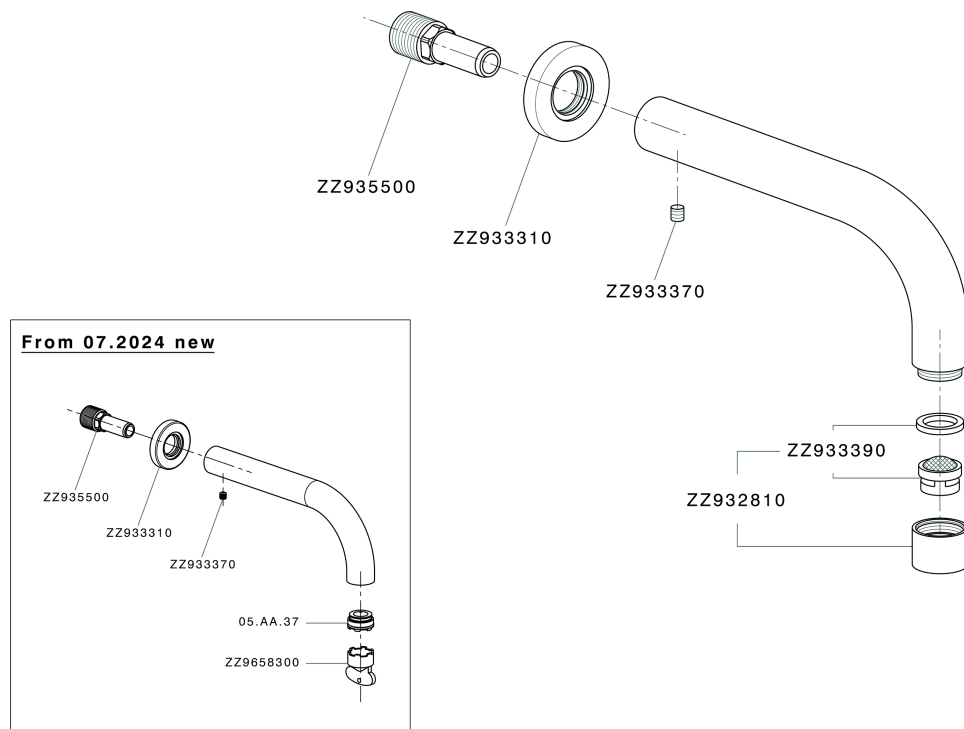

ZA001250

<https://en.cisal.it/spout-components-za001250>

2026-05-20