

Free Standing Progressive Shower Column WELLNESS_MR005130

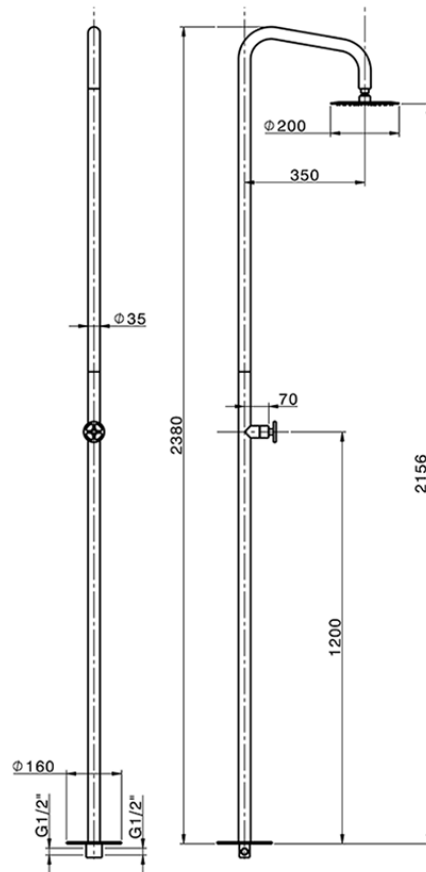

MR005130

<https://en.cisal.it/free-standing-progressive-shower-column-wellness-mr005130>

2026-04-08