

Exposed part for thermostatic concealed valve PUSH&SHOWER_PS1G1020

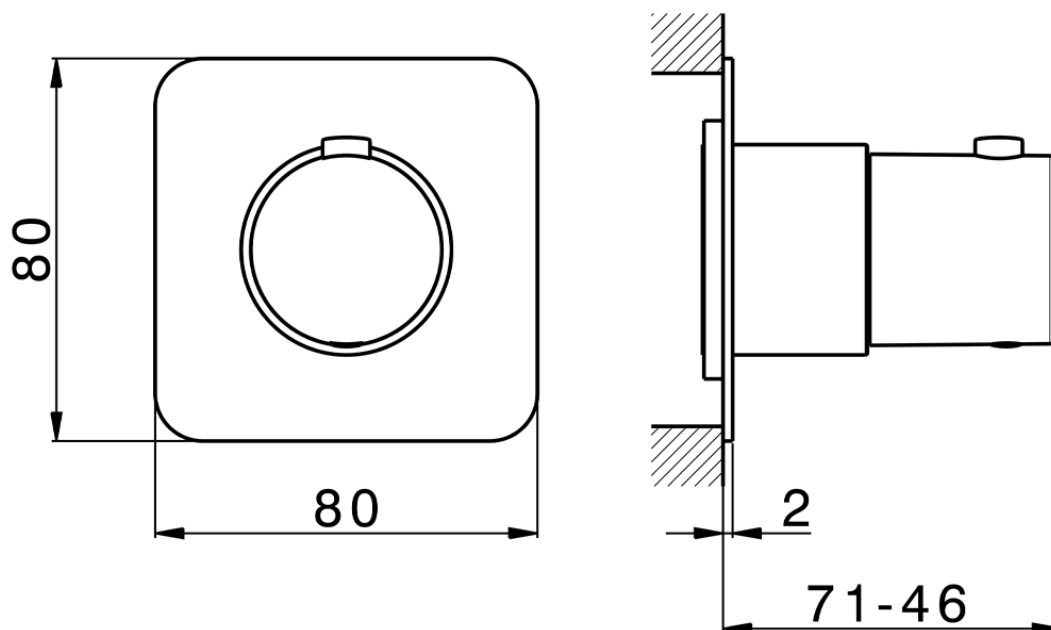

PS1G1020

<https://en.cisal.it/exposed-part-for-thermostatic-concealed-valve-pushshower-ps1g1020>

2026-04-08