

## Bath mixer, with full equipment GRACE\_GS000060

MODEL **GS000060**

Bath mixer, with full equipment, 60 cm Rail with slide bracket, 22,5 mm Brass One Spray handshower, 150 cm SUPREME smooth flexible hose

### AVAILABLE FINISHINGS

-  **21** 21 Chrome
-  **2F** 2F Brushed Nickel
-  **2W** 2W Brushed Gold
-  **5H** 5H Dark Brass Brushed
-  **5L** 5L Brushed Black Titanium
-  **6T** 6T Chrome/Matt Black

### CHARACTERISTICS

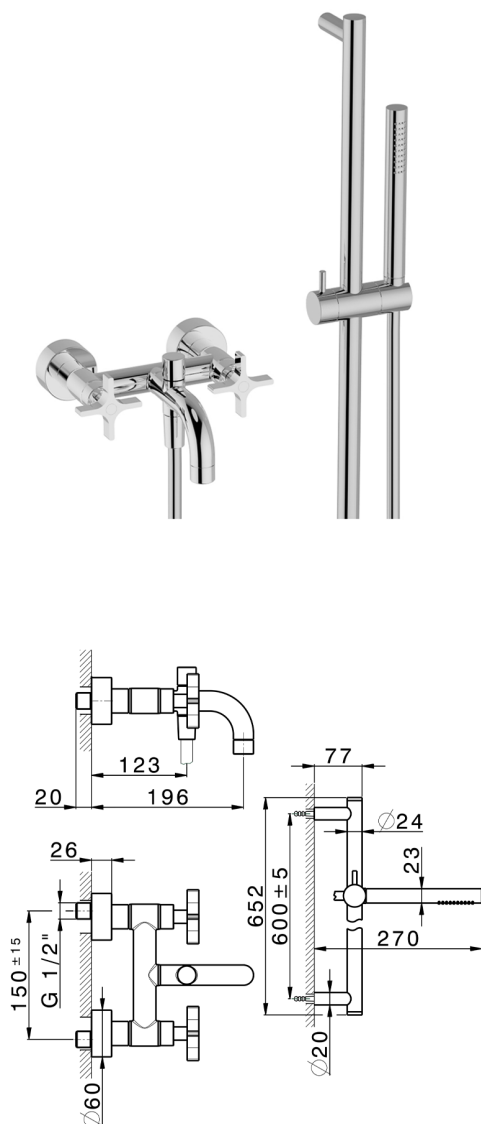

2026-05-03