

Exposed part for concealed washbasin mixer LINEAVIVA_LV013510

MODEL **LV013510**

Exposed part for concealed washbasin mixer, without concealed part, for item ZA033511

AVAILABLE FINISHINGS

-  **21** 21 Chrome
-  **2B** 2B Polished Nickel
-  **2F** 2F Brushed Nickel
-  **40** 40 Matt Black
-  **4Q** 4Q Matt White

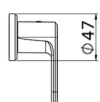
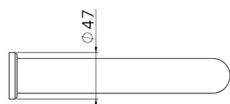
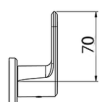
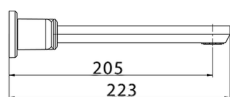
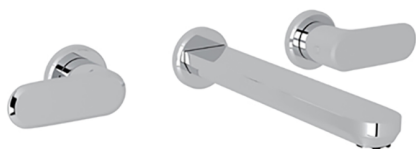

CHARACTERISTICS

Installation **Concealed**

Required concealed parts **ZA033511**



Concealed washbasin mixer CONCEALED_ZA033511

MODEL **ZA033511**

Concealed washbasin mixer, right headvalve - left headvalve

AVAILABLE FINISHINGS

 **04** 04 Without finishing



CHARACTERISTICS

Concealed **1**



2026-04-05