







Cover Part for 3 Function Concealed Thermo. Valve WELLNESS_RA01R300

MODEL **RA01R300**

Cover Part for 3 Function Concealed Thermo.Valve,for item ZA01R300

AVAILABLE FINISHINGS

-  **21** 21 Chrome
-  **2B** 2B Polished Nickel
-  **2F** 2F Brushed Nickel
-  **2Q** 2Q Black Titanium
-  **40** 40 Matt Black
-  **4Q** 4Q Matt White

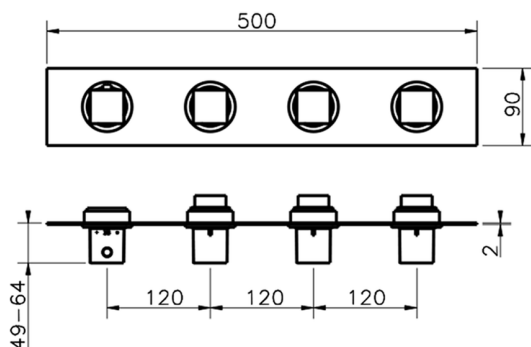
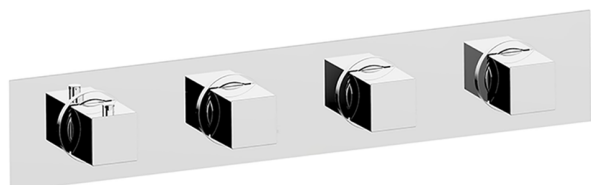

CHARACTERISTICS

Installation **Concealed**
 Required concealed parts **ZA01R300**



Thermostatic

The Cisal thermostatic is your personal water manager, helping you to handle, control and save water and energy.



3 Function Concealed Thermostatic Built-in Part CONCEALED_ZA01R300

MODEL **ZA01R300**

3 Function Concealed Thermostatic Built-in Part

AVAILABLE FINISHINGS

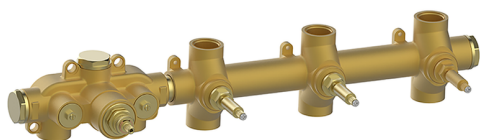
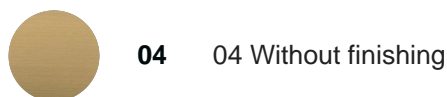

CHARACTERISTICS

Concealed **1**
 Cartridge Spare Parts **23.51A.HF**
HF Thermostatic Valve

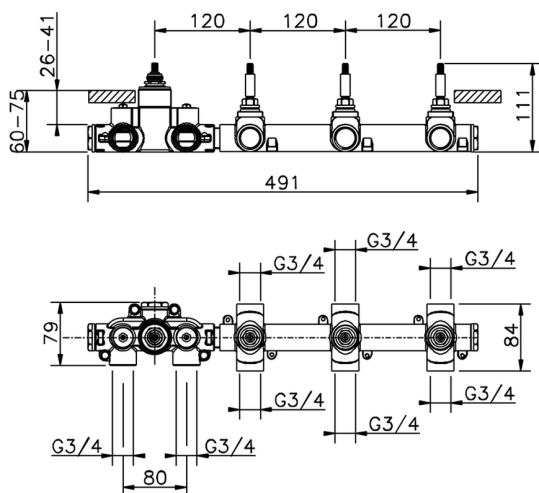

Thermostatic

The Cisal thermostatic is your personal water manager, helping you to handle, control and save water and energy.



2024-12-22