

## Towel holder BATHROOM ACCESSORIES\_AE090101

MODEL **AE090101**

Towel holder

AVAILABLE FINISHINGS



CHARACTERISTICS

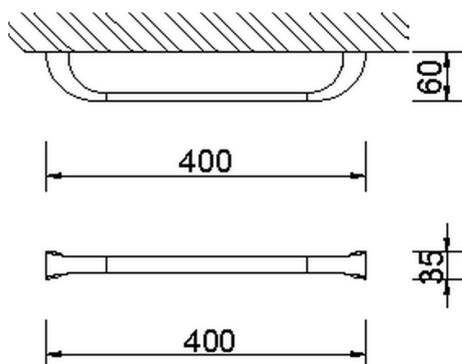
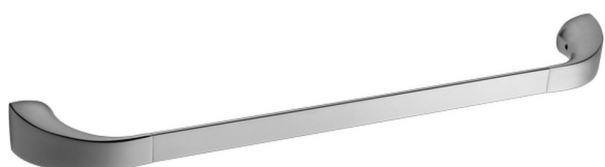

2026-04-06