

Pillar connection COMPONENTS_ZA003790

cisal

ZA 00379

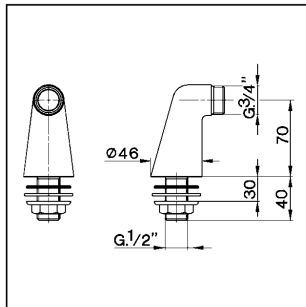

- Raccordo verticale
- Vertical connection
- Standanschluss-Ventil
- Raccord colonnette

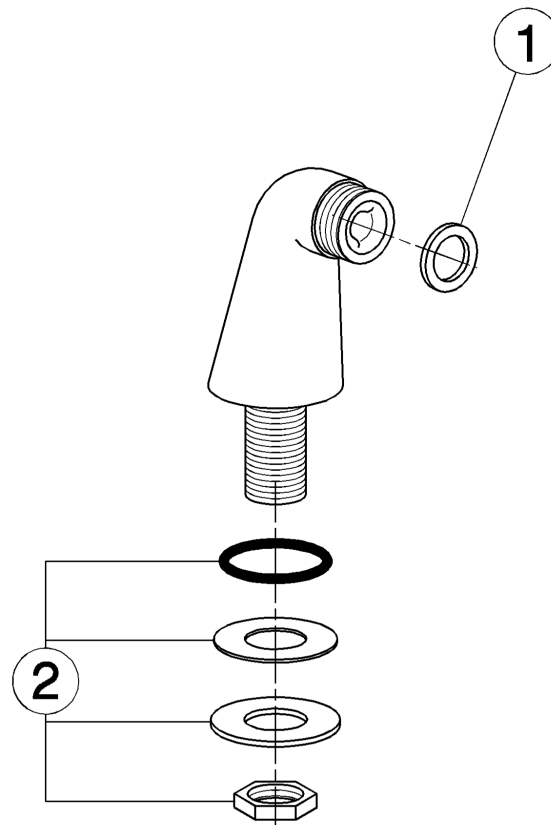

NR.	DESCRIZIONE DESCRIPTION BESCHREIBUNG DÉSCRIPTION	N. CODICE CODE NO. WERKSNR. NR. CODE	NR.	DESCRIZIONE DESCRIPTION BESCHREIBUNG DÉSCRIPTION	N. CODICE CODE NO. WERKSNR. NR. CODE	NR.	DESCRIZIONE DESCRIPTION BESCHREIBUNG DÉSCRIPTION	N. CODICE CODE NO. WERKSNR. NR. CODE
1	Guarnizione NBR 90 SH, 24x16x2,7 Gasket NBR 90 SH, 24x16x2,7 Dichtung NBR 90 SH, 24x16x2,7 Joint NBR 90 SH, 24x16x2,7	ZZ 92689 0						
2	Set installazione raccordo verticale Installation set for vertical connection Befestigungssatz Stand-Anschluss-Ventil Set installation	ZZ 92984 0						

ZA.6

ZA003790

<https://en.cisal.it/pillar-connection-components-za003790>

2026-06-13