

Extension +25 mm COMPONENTS_ZA008040

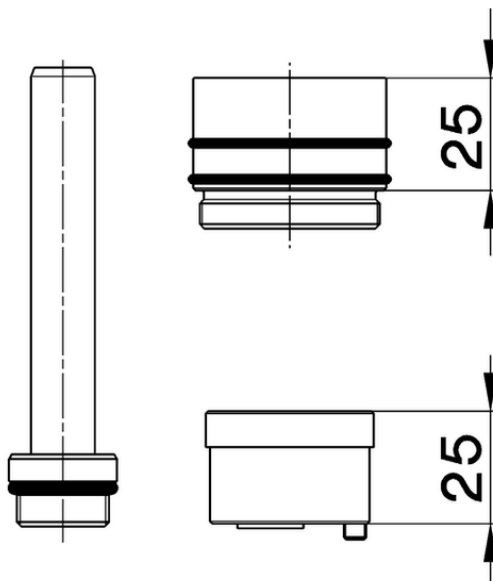

ZA008040

<https://en.cisal.it/extension-25-mm-components-za008040>

2026-04-08