

## Exposed part for concealed S.L. shower valve ROCK&ROLL\_RK003000C

MODEL **RK003000C**

Exposed part for concealed S.L. shower valve, without concealed part, for item ZA005300-ZA005301-ZA0G1700



### AVAILABLE FINISHINGS

-  **21** 21 Chrome
-  **2F** 2F Brushed Nickel
-  **40** 40 Matt Black
-  **2W** 2W Brushed Gold
-  **26** 26 Old Copper
-  **3W** 3W Brushed Black Titanium
-  **43** 43 Salvia
-  **44** 44 Graphite
-  **45** 45 Argilla
-  **46** 46 Metal Bronze
-  **47** 47 Cemento
-  **4Q** 4Q Matt White

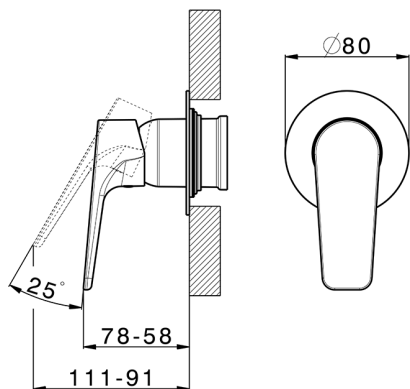

## CHARACTERISTICS

Installation **Concealed**

Required concealed parts **ZA0G1700**

**ZA005301**

**ZA005300**



## Exposed part for concealed S.L. shower valve ROCK&ROLL\_RK003000C

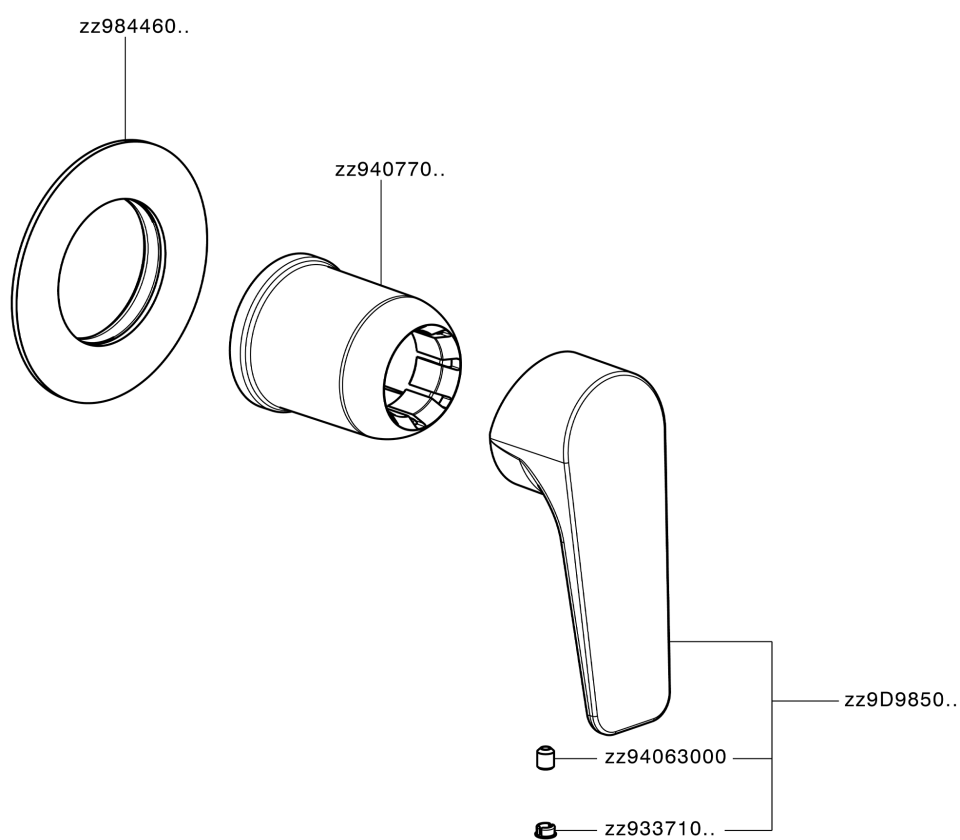

RK003000C

<https://en.cisal.it/exposed-part-for-concealed-s-l-shower-valve-rockroll-rk003000c>

## Concealed single lever shower mixer CONCEALED\_ZA005301

MODEL **ZA005301**

Concealed single lever shower mixer, 1/2" concealed shower, without trim kit, with noise reducers



AVAILABLE FINISHINGS



**04** 04 Without finishing

CHARACTERISTICS

Concealed **1**  
 Cartridge Spare Parts **ZZ94035000**  
**35 mm Cartridge**

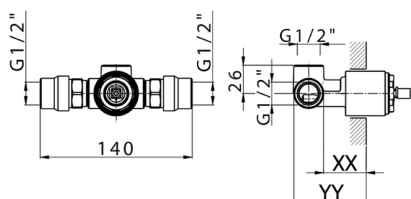

Piastra/Plate/Plaque/Platte/Placa  
 2-3mm: XX 27-47 YY 54-74  
 10mm: XX 16-40 YY 43-68



## Concealed single lever shower mixer CONCEALED\_ZA005300



MODEL **ZA005300**

Concealed single lever shower mixer, 1/2" concealed shower, without trim kit

AVAILABLE FINISHINGS

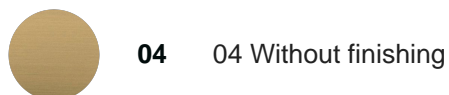

CHARACTERISTICS

Concealed **1**  
 Cartridge Spare Parts **ZZ94035000**  
**35 mm Cartridge**

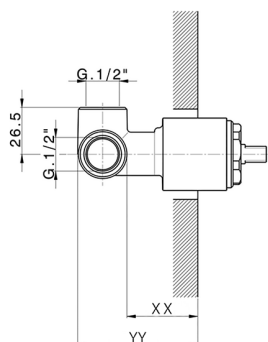

Piastra/Plate/Plaque/Platte/Placa  
 2-3mm: XX 27-47 YY 54-74  
 10mm: XX 16-40 YY 43-68



2026-06-14