

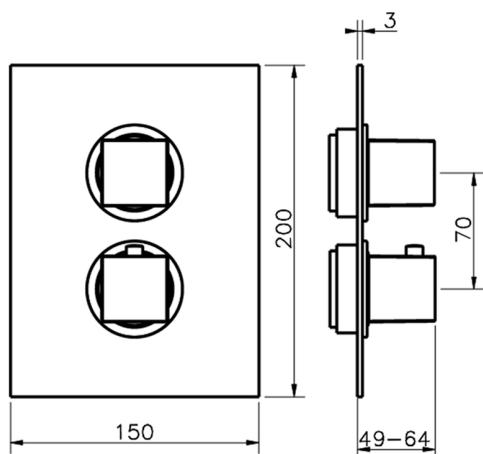





Exposed part for con.thermo.shower valve 1-outlet ROADSTER ACCENT_RA007300



MODEL **RA007300**

Exposed part for con.thermo.shower valve
1-outlet, stop valve, without concealed part, for items
ZA007301-ZA007361

AVAILABLE FINISHINGS

-  **21** 21 Chrome
-  **2B** 2B Polished Nickel
-  **2F** 2F Brushed Nickel
-  **2Q** 2Q Black Titanium
-  **40** 40 Matt Black
-  **4Q** 4Q Matt White

CHARACTERISTICS

Installation **Concealed**
Required concealed parts **ZA007301**



Thermostatic

The Cisal thermostatic is your personal water manager, helping you to handle, control and save water and energy.



Concealed thermostatic shower valve, 1-outlet CONCEALED_ZA007301

MODEL **ZA007301**

Concealed thermostatic shower valve,
1-outlet, Stopvalve with 1/2" outlet, without trim kit



AVAILABLE FINISHINGS

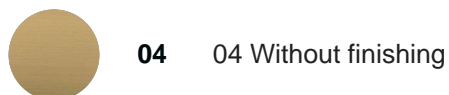

CHARACTERISTICS

Concealed **1**
Cartridge Spare Parts **24.04A.PP**
8x20 Plus P Thermostatic Valve

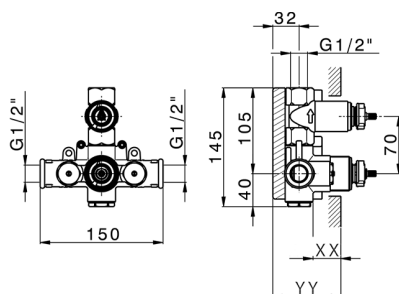

Piastra/Plate/Plaque/Platte/Placa
2-3mm: XX 25-40 YY 76-91
10mm: XX 16-31 YY 65-80



Thermostatic

The Cisal thermostatic is your personal water manager, helping you to handle, control and save water and energy.



2024-12-22