

## Exposed part for individual Push&Shower PUSH&SHOWER\_PS1G6320

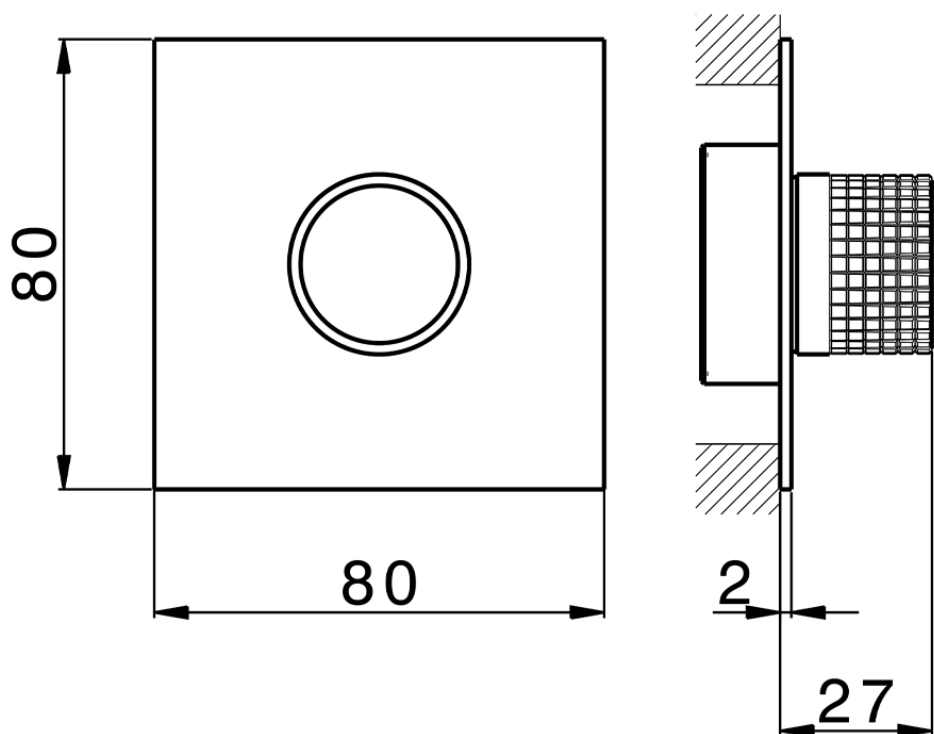

PS1G6320

<https://en.cisal.it/exposed-part-for-individual-pushshower-pushshower-ps1g6320>

2026-04-08