

Exposed part for con.thermo.shower mixer, 2-outlet WAVE_WE019100



MODEL **WE019100**

Exposed part for con.thermo.shower mixer, 2-outlet, with 2 outlet deviasstop, without concealed part, For item ZA019101

AVAILABLE FINISHINGS

-  **21** 21 Chrome
-  **2F** 2F Brushed Nickel
-  **2Q** 2Q Black Titanium

CHARACTERISTICS

Installation **Concealed**
 Required concealed parts **ZA019101**



Thermostatic

The Cisal thermostatic is your personal water manager, helping you to handle, control and save water and energy.



Concealed thermostatic shower mixer, 2-outlets CONCEALED_ZA019101

MODEL **ZA019101**

Concealed thermostatic shower mixer, 2-outlets, with 1/2" 2 outlet deviastop cartridge, without trim kit

AVAILABLE FINISHINGS

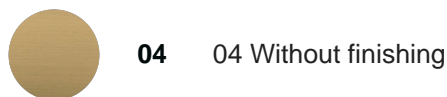

CHARACTERISTICS

Concealed **1**
 Cartridge Spare Parts **24.04A.PP**
8x20 Plus P Thermostatic Valve

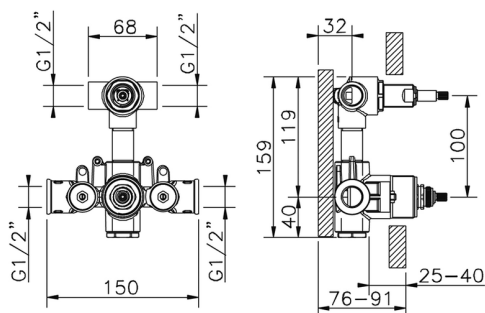

DeviaStop

The Cisal Devia Stop technology allows to adjust the water flow and to direct it to the selected output point (overhead soaker, hand shower, etc).



Thermostatic

The Cisal thermostatic is your personal water manager, helping you to handle, control and save water and energy.



2026-06-26