

## Exposed part for con.thermo.shower mixer, 2-outlet WAVE\_WE019100

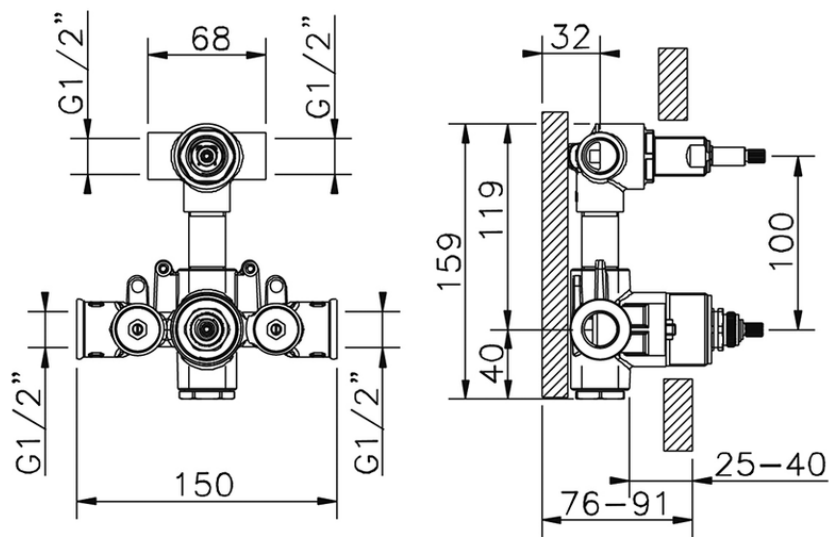

WE019100

<https://en.cisal.it/exposed-part-for-con-thermo-shower-mixer-2-outlet-wave-we019100>



ZA019101

<https://en.cisal.it/concealed-thermostatic-shower-mixer-2-outlets-concealed-za019101>

2026-06-05