







Double towel holder BATHROOM ACCESSORIES_SY090210

MODEL **SY090210**

Double towel holder,swivel

AVAILABLE FINISHINGS



-  **21** 21 Chrome
-  **2B** 2B Polished Nickel
-  **2F** 2F Brushed Nickel
-  **2P** 2P Rose Gold
-  **2Q** 2Q Black Titanium
-  **40** 40 Matt Black
-  **4Q** 4Q Matt White

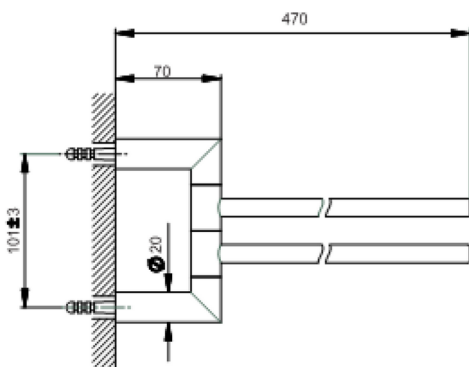

CHARACTERISTICS



Double towel holder BATHROOM ACCESSORIES_SY090210

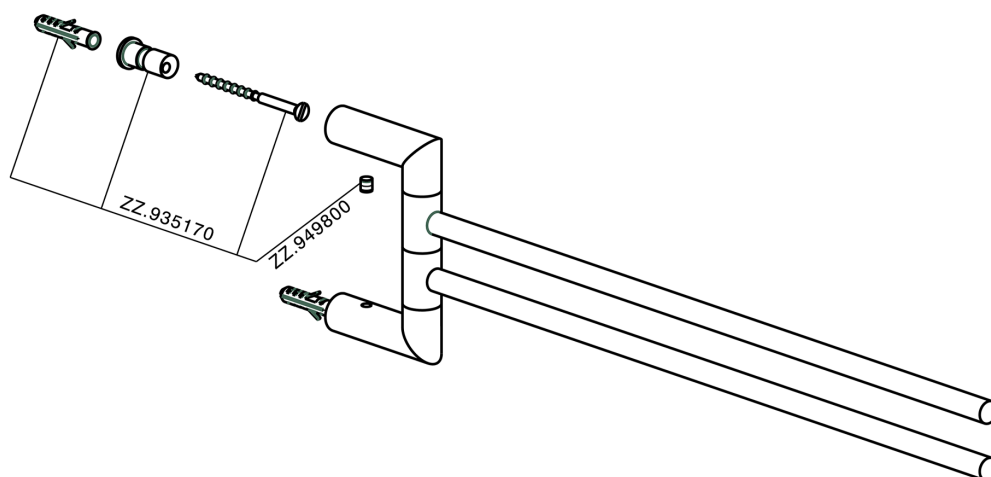

SY090210

<https://en.cisal.it/double-towel-holder-bathroom-accessories-sy090210>

2026-04-26