







Double towel holder BATHROOM ACCESSORIES_SY090210

MODEL **SY090210**

Double towel holder,swivel

AVAILABLE FINISHINGS



- 
21 21 Chrome
- 
2B 2B Polished Nickel
- 
2F 2F Brushed Nickel
- 
2P 2P Rose Gold
- 
2Q 2Q Black Titanium
- 
40 40 Matt Black
- 
4Q 4Q Matt White

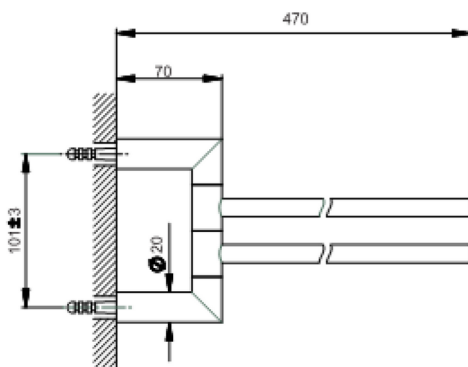

CHARACTERISTICS



Double towel holder BATHROOM ACCESSORIES_SY090210

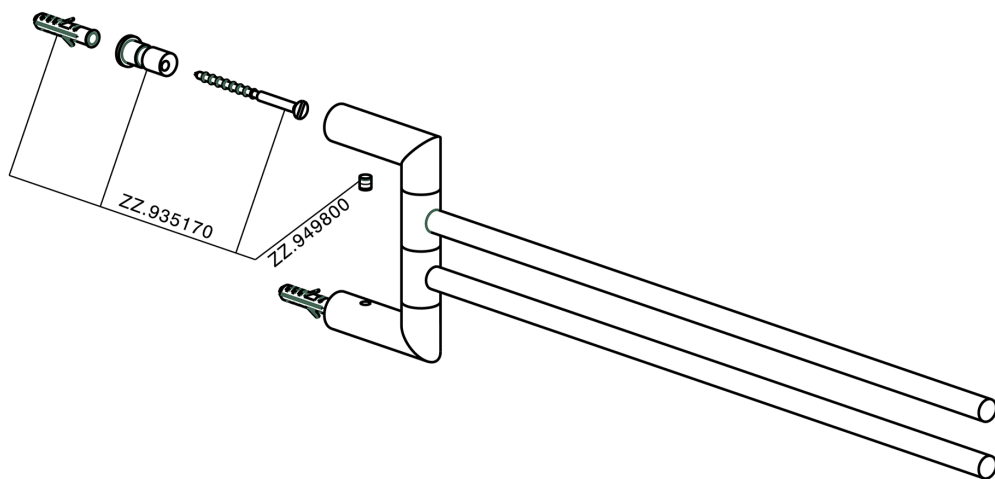

SY090210

<https://en.cisal.it/double-towel-holder-bathroom-accessories-sy090210>

2026-06-14