

Exposed single lever sink mixer CLINIC_CL000401

cisal

CL 00040

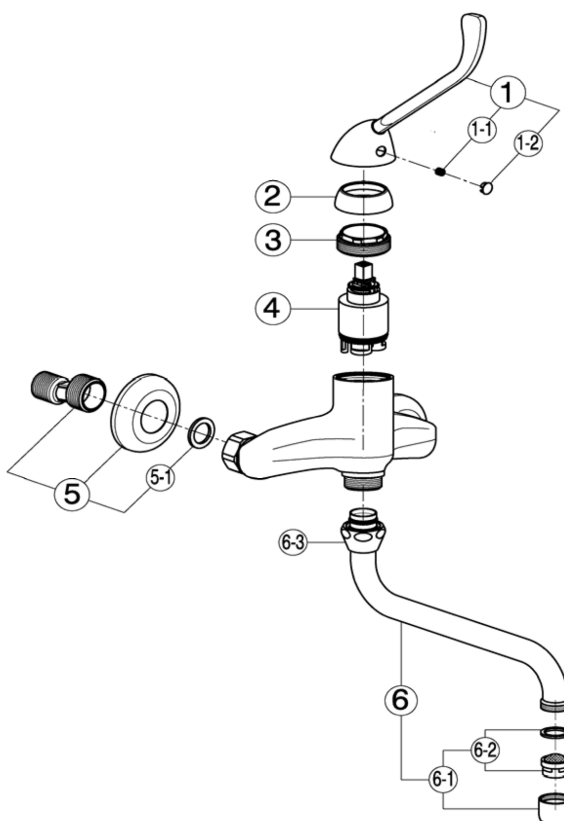
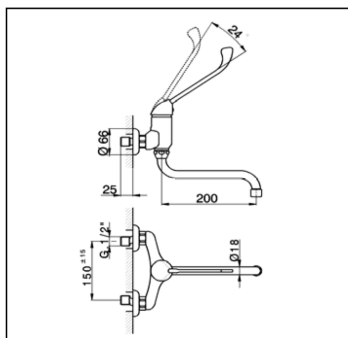

NR.	DESCRIZIONE DESCRIPTION BESCHREIBUNG DESCRIPTION	N.CODICE CODE NO. WERSKNR. NR.CODE	NR.	DESCRIZIONE DESCRIPTION BESCHREIBUNG DESCRIPTION	N.CODICE CODE NO. WERSKNR. NR.CODE	NR.	DESCRIZIONE DESCRIPTION BESCHREIBUNG DESCRIPTION	N.CODICE CODE NO. WERSKNR. NR.CODE
	Leva monocomando "CL"			Eccentrico con rosone				
1	Lever "CL" Hebel "CL" Levier "CL"	ZA005020	5	Excentric connection with escutcheon S - Anschluss m.Rosette Excentrique + rosace	ZZ927300			
	Grano punta coppa inox M.5x6			Guarnizione NBR 90 SH. 24x16x2,7				
1-1	Screw-stainless steel M.5x6 Madenschraube M.5x6 Vis speciale inox M.5x6	ZZ940630	5-1	Gasket NBR 90 SH. 24x16x2,7 Dichtung NBR 90 SH. 24x16x2,7 Joint NBR 90 SH. 24x16x2,7	ZZ926890			
	Piacchetta per leva			Canna a S Ø18 interasse 200				
1-2	Cap for lever Abdeckkappe f/Hebel Plaqueette levier	ZZ927100	6	Swinging spout 200 Ø18 Auslauf-Rohr-S-200 Ø18 Bec orientable 200 Ø18	ZZ928220			
	Copricartuccia senza ideogrammi			Aeratore M.22x1 IA				
2	Escutcheon cartridge without ideogram Abdeckkappe ohne Ideogramm Couvre-cartouche sans ideogramme Calotta bloccaggio cartuccia	ZZ940650	6-1	Mousseur M.22x1 IA Perlator M.22x1 IA Mousseur M.22x1 IA	ZZ928350			
	Nut for mixing valve Mutter f/kartusche Ecrou pour cartouche	ZZ940660	6-2	Cartuccia per aeratore M. 22x1 Mousseur cartridge M.22x1 Kart.f/Perlator M.22x1 Cartouche x mousseur M.22x1	ZZ927080			
4	Cartuccia monocomando Mixing valve Kartusche Cartouche mitigeurs	ZZ940340	6-3	Calotta 3/4" es.29 Ø19,5 Nut 3/4" Ø19,5 Mutter 3/4" Ø19,5 Ecrou 3/4" Ø19,5	ZZ926150			

CL000401

<https://en.cisal.it/exposed-single-lever-sink-mixer-clinic-cl000401>

2026-06-14