

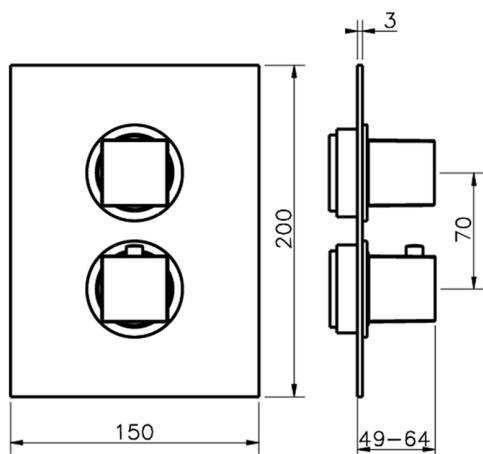





Exposed part for con.thermo.shower valve, 3-outlet ROADSTER ACCENT_RA018200



MODEL **RA018200**

Exposed part for con.thermo.shower valve,
3-outlet,with 3 outlet deviaSTOP,without concealed
part,for item ZA018201

AVAILABLE FINISHINGS

-  **21** 21 Chrome
-  **2B** 2B Polished Nickel
-  **2F** 2F Brushed Nickel
-  **2Q** 2Q Black Titanium
-  **40** 40 Matt Black
-  **4Q** 4Q Matt White

CHARACTERISTICS

Installation **Concealed**
Required concealed parts **ZA018201**



Thermostatic

The Cisal thermostatic is your personal water manager, helping you to handle, control and save water and energy.



Concealed thermostatic shower valve, 3-outlets CONCEALED_ZA018201

MODEL **ZA018201**

Concealed thermostatic shower valve, 3-outlets, with 1/2" 3 outlet deviastop cartridge, without trim kit



AVAILABLE FINISHINGS

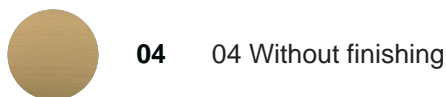

CHARACTERISTICS

Concealed **1**
 Cartridge Spare Parts **24.04A.PP**
8x20 Plus P Thermostatic Valve

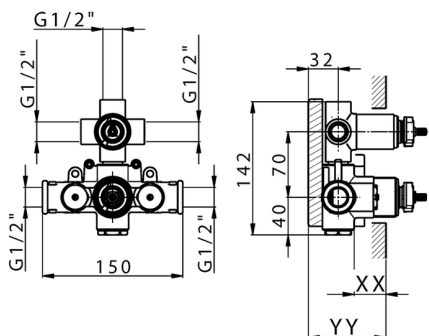

Piastra/Plate/Plaque/Platte/Placa
 2-3mm: XX 25-40 YY 76-91
 10 mm: XX 16-31 YY 65-80



DeviaStop

The Cisal Devia Stop technology allows to adjust the water flow and to direct it to the selected output point (overhead soaker, hand shower, etc).



Thermostatic

The Cisal thermostatic is your personal water manager, helping you to handle, control and save water and energy.



2024-12-21