

Cover Part for 3 Function Concealed Thermo. Valve SMOOTH X32_X300R300

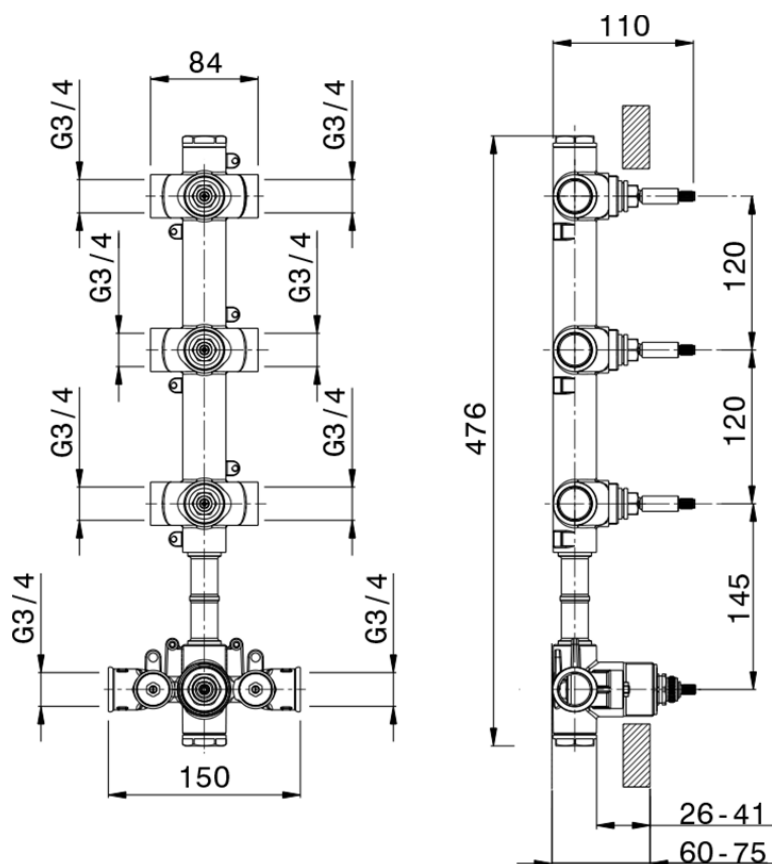

X300R300

<https://en.cisal.it/cover-part-for-3-function-concealed-thermo-valve-smooth-x32-x300r300>



ZA00V300

<https://en.cisal.it/3-function-concealed-thermostatic-built-in-part-concealed-za00v300>

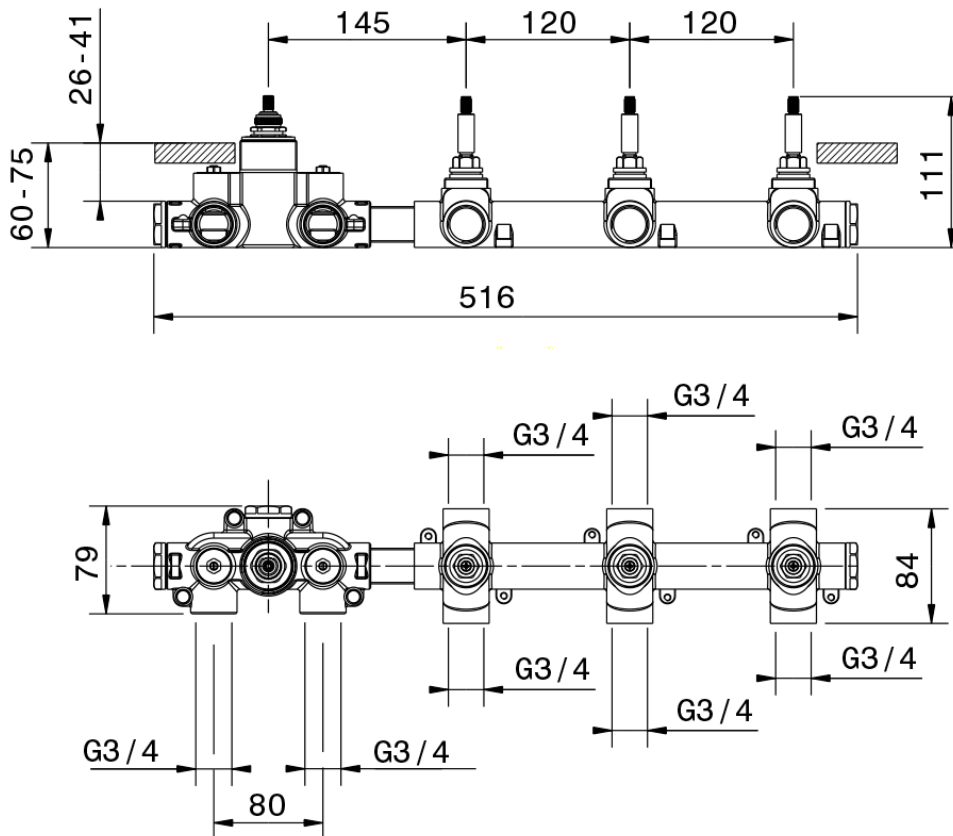

ZA00R300

<https://en.cisal.it/3-function-concealed-thermostatic-built-in-part-concealed-za00r300>

2026-06-13