





Exposed part for concealed washbasin mixer **SMOOTH X32_X4013511**

MODEL **X4013511**

Exposed part for concealed washbasin mixer, without concealed part, for item ZA033510, with smooth handles, Inox AISI 316L

AVAILABLE FINISHINGS

-  **5H** 5H Dark Brass Brushed
-  **5L** 5L Brushed Black Titanium
-  **5N** 5N Brushed Rose Gold
-  **D1** D1 Brushed Inox

CHARACTERISTICS

Installation **Concealed**

Required concealed parts **ZA033510**

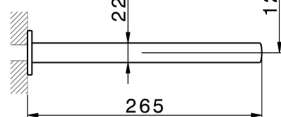
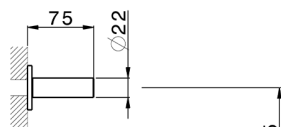
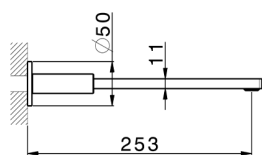

Concealed washbasin mixer CONCEALED_ZA033510

MODEL **ZA033510**

Concealed washbasin mixer, with two right headvalves

AVAILABLE FINISHINGS



04 04 Without finishing

CHARACTERISTICS

Concealed **1**

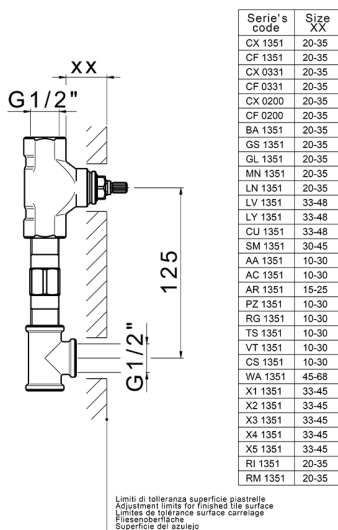

2024-10-18