

Concealed stop valve ARCANA CERAMIC_AC000310

MODEL **AC000310**

Concealed stop valve, 1/2" F outlet



AVAILABLE FINISHINGS

-  **21** 21 Chrome
-  **24** 24 Gold
-  **26** 26 Old Copper
-  **27** 27 Old Bronze
-  **2A** 2A Satin Brushed Nickel
-  **74** 74 Chrome/Gold

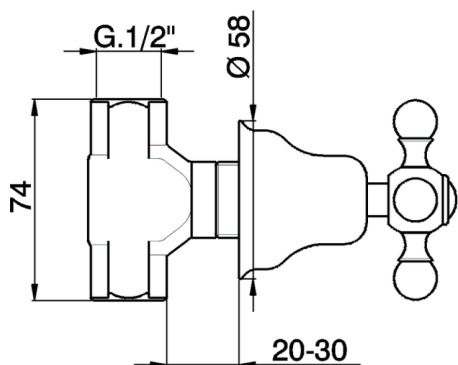

CHARACTERISTICS



Concealed stop valve ARCANA CERAMIC_AC000310

cisal

AC 00031

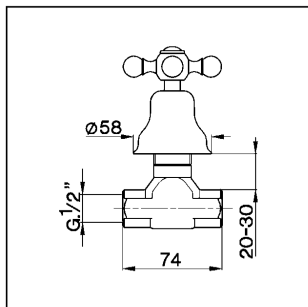

- Rubinetto incasso
- Concealed valve
- UP-Ventil
- Robinet à encastrer

bar	PORTATA * FLOW RATE DURCHFLOSS DEBIT l/min.
0.1	6.5
0.3	9
0.5	11.5
1	13.5
2	15
3	21.5

* senza resistenza silenziosa (uscita libera)
without hydraulic resistance
ohne Widerstand
sans résistance hydraulique

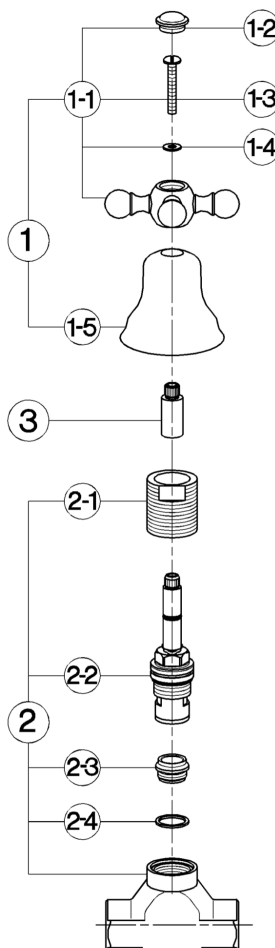

NR.	DESCRIZIONE DESCRIPTION BESCHREIBUNG DESCRIPTION	N. CODICE CODE NO. WERKSNR. NR. CODE	NR.	DESCRIZIONE DESCRIPTION BESCHREIBUNG DESCRIPTION	N. CODICE CODE NO. WERKSNR. NR. CODE	NR.	DESCRIZIONE DESCRIPTION BESCHREIBUNG DESCRIPTION	N. CODICE CODE NO. WERKSNR. NR. CODE
1	Maniglia con cappuccio "AR" Handle with escutcheon "AR" Griff "AR" mit Abdeckkappe Craisillon + rosace "AR"	ZZ 92980 0	2	Rubinetto incasso 1/2" Concealed stop cock 1/2" Unterputventil 1/2" Robinet à encastrer 1/2"	ZZ 92982 0	3	Prolunga asta vitone Extension for headvalve Verlängerung Rallonge	ZZ 92606 0
1-1	Maniglia "AR" con vite e placchetta Handle with screw and plate "AR" Griff "AR" mit Schraube und Abdeckkappe Craisillon avec vis et plaquette "AR"	ZZ 92981 0	2	Rubinetto incasso 3/4" Concealed stop cock 3/4" Unterputventil 3/4" Robinet à encastrer 3/4"	ZZ 92983 0			
1-2	Placchetta a vite maniglia "AR" Cap for handle "AR" Abdeckkappe "AR" Griff Plaquette cache - vis croix "AR"	ZZ 92617 0	2-1	Riduzione capp. bordo vasca e incasso Reduction for bath escutcheon Reduzierstück Reduction rosace	ZZ 92682 0			
1-3	Vite M.4,5x28,5 tc. Ø6x2 Screw M.4,5x28,5 Schraube M.4,5x28,5 Vis M.4,5x28,5	ZZ 92607 0	2-2	Vitone ceramico DX per batterie "AC" Ceramic headvalve 1/2" right "AC"-long Keramikoberteil 1/2"-rechts-"AC"-lang Tête céramique 1/2" droite "AC"-longue	ZZ 92859 0			
1-4	Rondella ottone 10x4,5x0,8 Ring in brass 10x4,5x0,8 Unterlegscheibe 10x4,5x0,8 Joint laiton 10x4,5x0,8	ZZ 92663 0	2-3	Sede rubinetto incasso 1/2" Seat 1/2" Sitz 1/2" Siège 1/2"	ZZ 92658 0			
1-5	Cappuccio a campana "AR" Escutcheon "AR" Abdeckkappe "AR" Rosace "AR"	ZZ 92598 0	2-4	Guarnizione rame 18,5x16,1x1 Gasket copper 18,5x16,1x1 Kupferdichtung 18,5x16,1x1 Joint cuivre 18,5x16,1x1	ZZ 92656 0			

AC.4

AC000310

<https://en.cisal.it/concealed-stop-valve-arcana-ceramic-ac000310>

2026-06-04