

Cover Part for 2 Function Concealed Thermo Valve WELLNESS_MN00R200

MODEL **MN00R200**

Cover Part for 2 Function Concealed Thermo Valve, for item ZA00R200 horizontal installation, for item ZA00V200 vertical installation

AVAILABLE FINISHINGS

-  **21** 21 Chrome
-  **2F** 2F Brushed Nickel
-  **2W** 2W Brushed Gold
-  **5H** 5H Dark Brass Brushed
-  **5L** 5L Brushed Black Titanium
-  **6T** 6T Chrome/Matt Black

CHARACTERISTICS

Installation **Concealed**
 Required concealed parts **ZA00V200**
ZA00R200

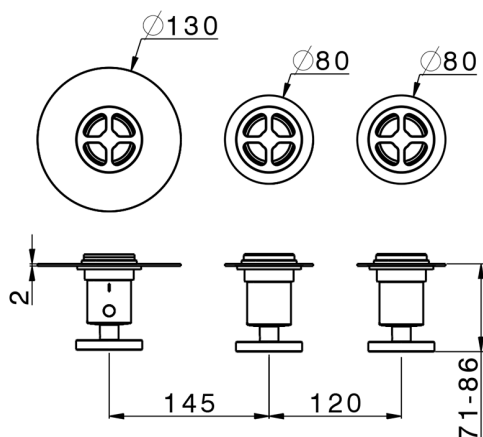

Thermostatic

The Cisal thermostatic is your personal water manager, helping you to handle, control and save water and energy.



2 Function Concealed Thermostatic Valve CONCEALED_ZA00V200

MODEL **ZA00V200**

2 Function Concealed Thermostatic Valve

AVAILABLE FINISHINGS



04 04 Without finishing

CHARACTERISTICS

Concealed **1**
 Cartridge Spare Parts **23.51A.HF**
HF Thermostatic Valve



Thermostatic

The Cisal thermostatic is your personal water manager, helping you to handle, control and save water and energy.



2 Function Concealed Thermostatic Valve CONCEALED_ZA00R200

MODEL **ZA00R200**

2 Function Concealed Thermostatic Valve

AVAILABLE FINISHINGS



CHARACTERISTICS

Concealed **1**
 Cartridge Spare Parts **23.51A.HF**
HF Thermostatic Valve



Thermostatic

The Cisal thermostatic is your personal water manager, helping you to handle, control and save water and energy.



2026-06-04