

2 Function Concealed Thermostatic Valve CONCEALED_ZA01V200

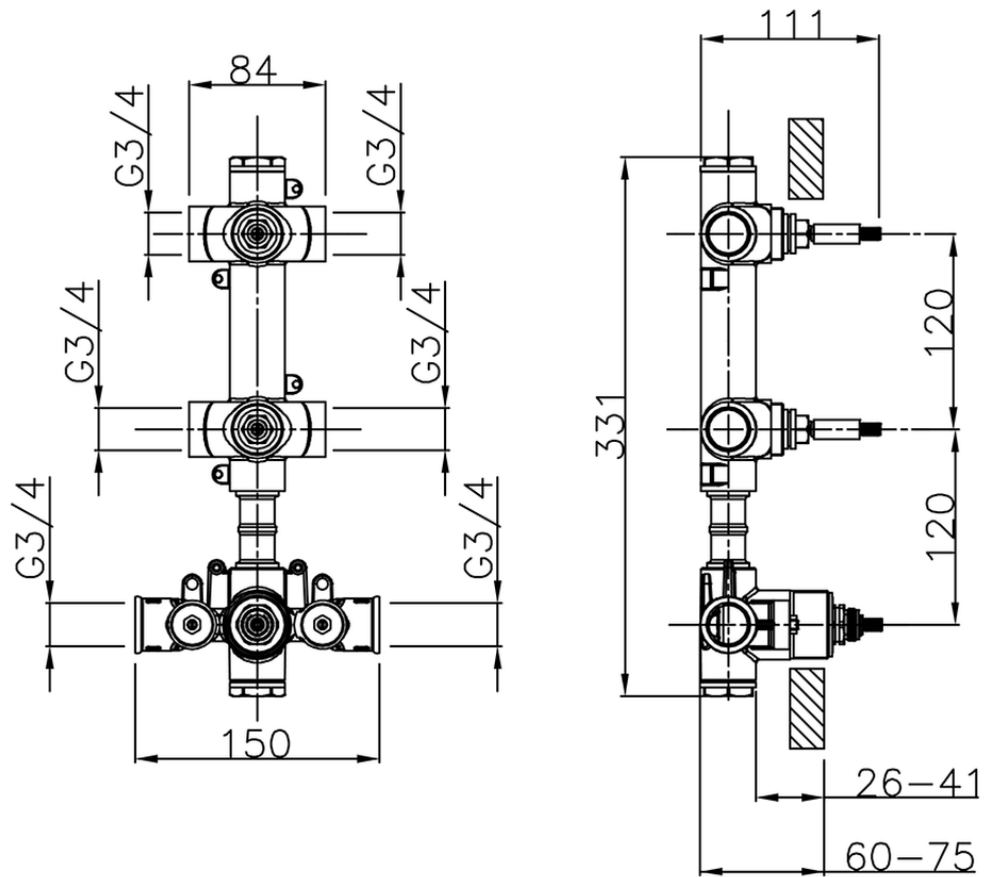

ZA01V200

<https://en.cisal.it/2-function-concealed-thermostatic-valve-concealed-za01v200>

2026-04-04