



Exposed part for concealed washbasin mixer WAVE_WA013510

MODEL **WA013510**

Exposed part for concealed washbasin mixer, without concealed part, for item ZA033511

AVAILABLE FINISHINGS

-  **21** 21 Chrome
-  **2F** 2F Brushed Nickel
-  **2Q** 2Q Black Titanium

CHARACTERISTICS

Installation **Concealed**

Required concealed parts **ZA033511**

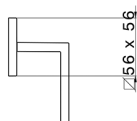
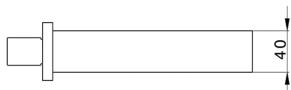
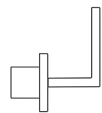
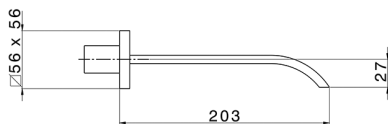
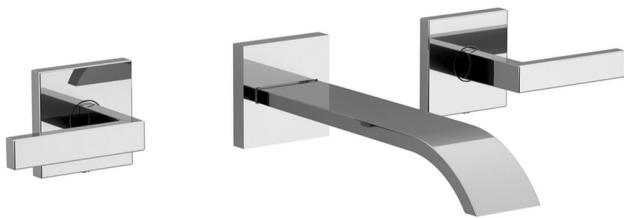

Concealed washbasin mixer CONCEALED_ZA033511

MODEL **ZA033511**

Concealed washbasin mixer, right headvalve - left headvalve

AVAILABLE FINISHINGS

 **04** 04 Without finishing

CHARACTERISTICS

Concealed **1**

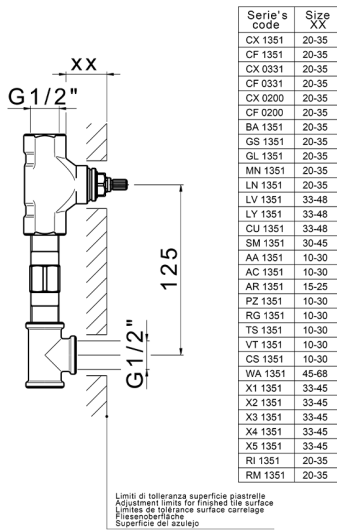

2026-04-28